

TZ

WA

24

Wussten Sie, dass durch die Fusion der Firmen SCHMITZ und WILA im Jahr 2017 zwei der traditionsreichsten Leuchten-Unternehmen Deutschlands zusammengefunden haben?

WILA wurde bereits 1857 in Iserlohn gegründet und produzierte ursprünglich Messing-Gussteile und Möbelbeschläge. Ab 1932 lag die Konzentration auf technischen Beleuchtungslösungen. Gerade die ALPHABET und TENTEC Downlight-Familien sind seit Jahren bei Lichtplanern und Lichtplanerinnen als hochwertige Beleuchtungswerkzeuge geschätzt und bekannt.

Gegründet im Jahr 1932 in Arnsberg, steht auch SCHMITZ für eine lange Historie und für die Bereitstellung von technologisch hochwertigem Design und individuellen Beleuchtungslösungen. Besonders die Einführung des „G-Concept“ getauften Systems, das beide Welten - Trockenbau und lineare Lichttechnik - auf einfachste Weise miteinander verbindet, hat den Namen SCHMITZ nachhaltig geprägt.

Heute erfüllt die SCHMITZ-WILA GmbH als Essenz aus beiden Marken höchste Anforderungen an Licht- und Verarbeitungsqualität für die Anwendungen Büro, Gastronomie, Hotel, Handel und Architektur.

Did you know that the merger of SCHMITZ and WILA in 2017 united two of Germany's most traditional lighting companies?

WILA was founded in Iserlohn in 1857 and originally produced brass castings and furniture fittings. Since 1932, the focus has been on technical lighting solutions. The ALPHABET and TENTEC Downlight families have long been valued and are still recognized by lighting planners as high-quality lighting tools.

Founded in Arnsberg in 1932, SCHMITZ also represents a long history and is known for providing technologically superior design and individual lighting solutions. Especially the introduction of the 'G-Concept' system, which effortlessly combines drywall and linear lighting technology, has significantly shaped the SCHMITZ brand.

Today, SCHMITZ-WILA GmbH, embodying the essence of both brands, meets the highest standards of lighting and manufacturing quality for office, gastronomy, hotel, retail and architectural applications.



DIALOG

Man sagt den Menschen im Sauerland Bodenständigkeit und Weltoffenheit gleichermaßen zu. Zwei Eigenschaften, die sicherlich dazu beigetragen haben, dass sich hier in der Region eine Reihe von Technologie-Unternehmen entwickelt haben, die in ganz Europa bekannt sind. Bei SCHMITZ-WILA kommt übrigens noch das ausgeprägte Perfektionsstreben bei den eigenen Produkten hinzu.

Wir reden vielleicht etwas weniger hier im Sauerland, aber wir können sehr gut zuhören und kommen schnell auf den Punkt. Das schätzen unsere Kunden sehr. Etliche unserer Produkte sind in Zusammenarbeit mit Lichtplanern, Architekten oder auch Elektro-Installateuren entstanden. Gerade das Projektgeschäft bringt viele Anforderungen mit, die oft nicht im Katalog zu finden sind - und von uns maßgeschneidert angepasst oder neuentwickelt werden.

Das genau ist der Grund, weshalb wir sehr viel Wert auf den aktiven Austausch mit Ihnen legen. Erwarten Sie also kein Call-Center oder eine Stimme vom Band, wenn Sie uns anrufen. Hier sprechen Menschen. Unser Team freut sich auf den Dialog mit Ihnen!

People in the Sauerland region are attributed with both down-to-earthness and cosmopolitanism. These two qualities have undoubtedly contributed to the development of a number of technology companies that are well-known throughout Europe. At SCHMITZ-WILA, there is also a pronounced pursuit of perfection in our own products.

We may speak less here in Sauerland, but we listen very well and get to the point quickly. Our customers really appreciate this. Many of our products have been developed in collaboration with lighting designers, architects, or electrical installers. The project business often brings many requirements that are not found in the catalogue - and are custom-tailored or newly developed by us.

This is precisely why we place great value on active exchange with you. So, don't expect a call center or a recorded voice when you call us. It's about real people. Our team looks forward to the dialogue with you!

FOLLOW US



QUALITY

Unverwechselbare Eigenschaften zeichnen die hochwertigen Lichtwerkzeuge von SCHMITZ-WILA aus:

SEHR EINFACHE UND SCHNELLE WERKZEUGLOSE MONTAGE - CLEAR EVO - Die neue Generation unserer Wand- und Deckenleuchtenfamilie ist mit einer „Fast-Connect“-Kupplung ausgestattet

EXTREM FLACHER LEUCHTENKOPF - FACTORY SLIM - Die neue hocheffiziente Referenz unserer Stehleuchten ist mit einem nur 21 mm flachen Leuchtenkopf ausgestattet

EINDRUCKSVOLLE DIMENSIONEN - VOLUMA - Die Ringleuchten mit bis zu 1.850 mm im Durchmesser füllen selbst große Räume mit hohen Decken mit Leben

PERFEKTE RUNDUMENTBLENDUNG - ALPHABET ZONO - Das umfassende Downlight-Portfolio erfüllt höchste Ansprüche an Sehaufgaben

AUSGELEUCHTET BIS IN DEN LETZTEN MILLIMETER - S55 Direct/ Indirect - Die Lichttechnik für unser lineares Profilsystem ist auf homogene Wahrnehmung optimiert: keine Dunkelzellen

OPTIMIERTES THERMOMANAGEMENT - Die Kühlkörper unserer Downlight-Familien sind individuell und speziell entwickelt, hochwertige Materialien und beste Wärmeleitfähigkeit garantieren eine lange Lebensdauer

Lassen Sie sich auf den folgenden Seiten von unserem Portfolio inspirieren.

Distinctive features characterise the high-quality lighting tools of SCHMITZ-WILA:

EASY AND QUICK TOOLLESS INSTALLATION - CLEAR EVO - The new generation of our wall and ceiling mounted lighting fixtures family is equipped with a "fast-connect" coupling

ULTRA-THIN LUMINAIRE HEAD - FACTORY SLIM - The new highly efficient benchmark of our floor luminaires comes with a mere 21 mm thin light head

IMPRESSIVE DIMENSIONS - VOLUMA - The Ring Lights with a diameter of up to 1,850 mm fill even large rooms with high ceilings with life

PERFECT ALL-ROUND GLARE CONTROL - ALPHABET ZONO - The comprehensive downlight portfolio meets the highest demands for visual tasks

ILLUMINATED TO THE LAST INCH - S55 Direct/ Indirect - The lighting technology for our linear profile system is optimised for homogeneous perception: absolutely no dark areas

OPTIMISED THERMAL MANAGEMENT - The heat sinks of our downlight families are customised and specially developed, high-quality materials and the best thermal conductivity guarantee a long service life

Be inspired by our portfolio on the following pages.

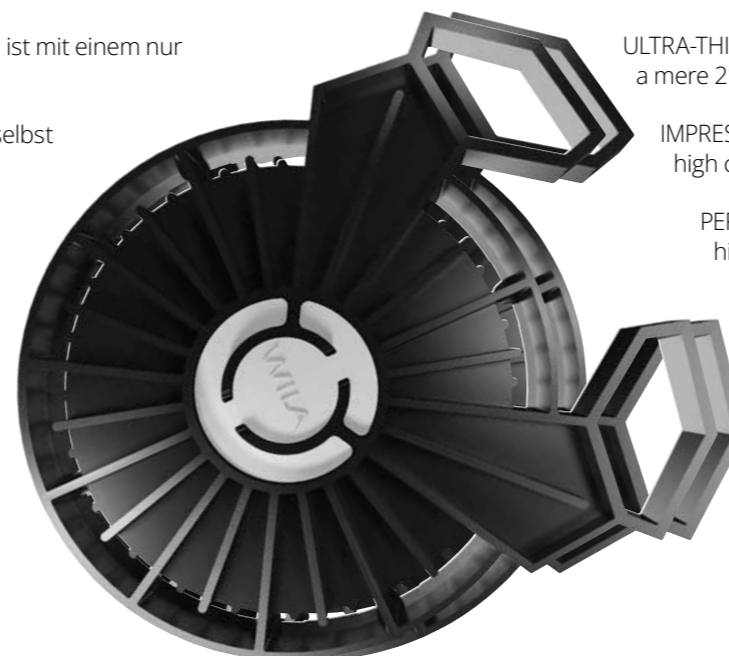

PORTFOLIO

POINT Punktuelles Licht | Point light

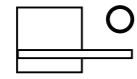

ALPHABET ZONO

Seite | Page 4 - 7



TENTEC 3

Seite | Page 8 - 13



TENTEC FLAT

Seite | Page 14 - 15



TENTEC ZONO

Seite | Page 16 - 19



TENTEC SL

Seite | Page 20 - 23



SPOT

Seite | Page 24 - 27



SIRO

Seite | Page 28 - 29



PUCKXT

Seite | Page 30 - 31

PLANE Flächiges Licht | Plane light

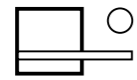

CLEAR 4.0

Seite | Page 32 - 35
 36 - 37



CLEAR FLAT

Seite | Page 38 - 40
 41



CLEAR DIRECT

Seite | Page 42 - 45
 46 - 47



CLEAR EVO

Seite | Page 48 - 53



LUNO SLIM

Seite | Page 54 - 55



TZ-T

Seite | Page 56 - 59



CALVIA

Seite | Page 60 - 61



CLOUD

Seite | Page 62 - 63



TRANSPARENCY

Seite | Page 64 - 65



VOLUMA

Seite | Page 66 - 67

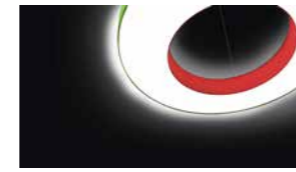

ROTONDA

Seite | Page 68 - 69
 70 - 71



PEARL

Seite | Page 72 - 73



FACTORY | FACTORY 3

Seite | Page 74 - 75



PARO

Seite | Page 74 - 75



FACTORY SLIM

Seite | Page 76 - 77



VELTO

Seite | Page 78 - 79

LINEAR Lineares Licht | Linear light

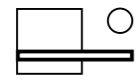

STRONG 30

Seite | Page 80 - 83



INFINITE SLIM

Seite | Page 84 - 85
 86 - 87



STRONG 40

Seite | Page 88 - 93



STRONG 40+

Seite | Page 94 - 97



S55

Seite | Page 98 - 105



STRONG 55

Seite | Page 106 - 109



STRONG ROUND

Seite | Page 110 - 111



STRADA

Seite | Page 112 - 115



GREAT

Seite | Page 116 - 117



G-CONCEPT

Seite | Page 118 - 119

TAILOR MADE

Seite | Page 120 - 121



ALPHABET ZONO

HÖCHSTER SEHKOMFORT,
GROSSE PROGRAMMVIelfALT UND
MAXIMALE WIRTSCHAFTLICHKEIT

- Perfekte Rundumentblendung
- f3-Montagetechnik mit nur 2 mm Aufbauhöhe
- Problemlöser, insektendichte Version und Einbautiefe 49 mm
- Lichtdichtes Leuchtgehäuse
- Hocheffiziente Lichtkammer dank Primärreflektor
- Betonarmaturen zur einfachen Montage auf Anfrage

HIGHEST VISUAL COMFORT,
GREAT PROGRAM DIVERSITY AND
MAXIMUM EFFICIENCY

- Perfect all-round glare control
- f3 mounting technique with only 2 mm visible height
- Problem solver, insect-proof version and recessed depth 49 mm
- Light-proof luminaire housing
- Highly efficient light chamber thanks to a secondary reflector
- Concrete mounting boxes on request



HVB Tower München | Henn Architekturbüro, München | Schmidt König Lichtplaner, München | Ingenieurbüro Knab, München | Foto HGEsch, Hennef

ALPHABET ZONO Downlights

DOWNLIGHT	D	DA CO	R	H	ET RD	CCT	Treiber	Leistung	UGR < 19	CRI > 80	3000 K	4000 K	DALI	IP20	Art.-Nr. Item No.
Reflektor hochglanz silber	mm	mm		mm	mm		Driver	Wattage							
Reflector highpolished silver															

	o 172	o 165	R15	125	170	3000 K	DALI	2950 lm/28 W							AZ-1154-12-30
	o 172	o 165	R15	125	170	4000 K	DALI	3120 lm/28 W							AZ-1154-12-40
	o 202	o 195	R18	125	170	3000 K	DALI	3040 lm/28 W							AZ-1164-12-30
	o 202	o 195	R18	125	170	4000 K	DALI	3210 lm/28 W							AZ-1164-12-40

L x B | W mm

	□ 177	□ 170	Q15	125	170	3000 K	DALI	2750 lm/28 W							AZ-2154-12-30
	□ 177	□ 170	Q15	125	170	4000 K	DALI	2910 lm/28 W							AZ-2154-12-40
	□ 207	□ 200	Q18	125	170	3000 K	DALI	2790 lm/28 W							AZ-2164-12-30
	□ 207	□ 200	Q18	125	170	4000 K	DALI	2950 lm/28 W							AZ-2164-12-40

DOWNLIGHT	D	DA CO	R	H	ET RD	CCT	Treiber	Leistung	UGR < 19	CRI > 80	3000 K	4000 K	DALI	IP20	Art.-Nr. Item No.
Corona H 20 mm	mm	mm		mm	mm		Driver	Wattage							

	o 172	o 165	R15	125	175	3000 K	DALI	2350 lm/28 W							AZ-1754-12-30
	o 172	o 165	R15	125	175	4000 K	DALI	2490 lm/28 W							AZ-1754-12-40
	o 202	o 195	R18	125	175	3000 K	DALI	2500 lm/28 W							AZ-1764-12-30
	o 202	o 195	R18	125	175	4000 K	DALI	2640 lm/28 W							AZ-1764-12-40

L x B | W mm

	□ 177	□ 170	Q15	125	175	3000 K	DALI	2360 lm/28 W							AZ-2754-12-30
	□ 177	□ 170	Q15	125	175	4000 K	DALI	2500 lm/28 W							AZ-2754-12-40
	□ 207	□ 200	Q18	125	175	3000 K	DALI	2480 lm/28 W							AZ-2764-12-30
	□ 207	□ 200	Q18	125	175	4000 K	DALI	2620 lm/28 W							AZ-2764-12-40

Variante | Version
ALPHABET ZONO

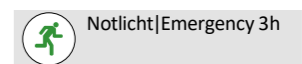
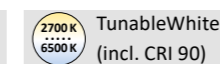
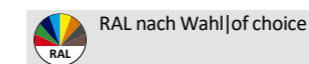
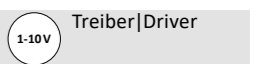
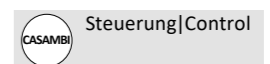
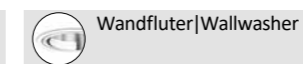

Weitere Notlicht-Varianten auf Anfrage
Emergency lighting variants on request

Dank des Abschirmwinkels von $\alpha 30^\circ$ bietet ALPHABET ZONO durchgängig eine perfekte Abschirmung gegen Blendung. Die hochwirksame Lichtkammer mit integriertem Diffusor sorgt mit ihrer innovativen Mikroperlentechnologie für reduzierte Leuchtdichten.

With a cut-off angle of 30° ALPHABET ZONO provides a consistent perfect shielding against glare. Below this 30° angle no visible glare effect is recognisable inside the mirror reflector made of pure aluminium. The highly efficient light chamber with built-in diffuser ensures reduced luminance levels thanks to its innovative micro pearl technology.

Bibliothek am Bauhaus, Dresden | Reiner Becker Architekten, Berlin | Bauer + Zuber, Gräfenhainich | Foto Werner Huthmacher, Berlin





ALPHABET ZONO Downlights

DOWNLIGHT ET RD 49 mm	D	DA CO	R	H	ET RD	CCT	Treiber	Leistung	Art.-Nr. Item No.
Streuscheibe	mm	mm		mm	mm		Driver	Wattage	
Diffusing screen									



	o 172	o 165	R15	49	49	3000 K	DALI	1780 lm/15 W	AZ-1454-12-30
	o 172	o 165	R15	49	49	4000 K	DALI	1840 lm/15 W	AZ-1454-12-40
	o 202	o 195	R18	49	49	3000 K	DALI	2390 lm/19 W	AZ-1464-12-30
	o 202	o 195	R18	49	49	4000 K	DALI	2470 lm/19 W	AZ-1464-12-40

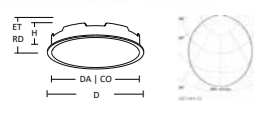

L x B | W mm

	□ 177	□ 170	Q15	49	49	3000 K	DALI	1870 lm/15 W	AZ-2454-12-30
	□ 177	□ 170	Q15	49	49	4000 K	DALI	1930 lm/15 W	AZ-2454-12-40
	□ 207	□ 200	Q18	49	49	3000 K	DALI	2510 lm/19 W	AZ-2464-12-30
	□ 207	□ 200	Q18	49	49	4000 K	DALI	2590 lm/19 W	AZ-2464-12-40

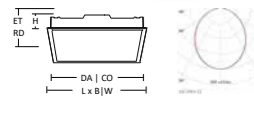

ALPHABET ZONO Downlights

DOWNLIGHT IP54	D	DA CO	R	H	ET RD	CCT	Treiber	Leistung	Art.-Nr. Item No.
Schutzscheibe, insektdicht	mm	mm		mm	mm		Driver	Wattage	
Safety screen, insect-proof									

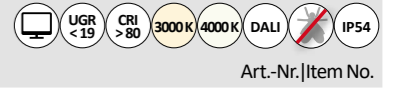

	o 172	o 165	R15	125	175	3000 K	DALI	2510 lm/28 W	AZ-1554-12-30
	o 172	o 165	R15	125	175	4000 K	DALI	2650 lm/28 W	AZ-1554-12-40
	o 202	o 195	R18	125	175	3000 K	DALI	2570 lm/28 W	AZ-1564-12-30
	o 202	o 195	R18	125	175	4000 K	DALI	2720 lm/28 W	AZ-1564-12-40

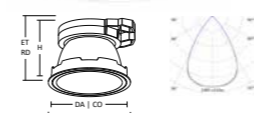

L x B | W mm

	□ 177	□ 170	Q15	125	175	3000 K	DALI	2240 lm/28 W	AZ-2554-12-30
	□ 177	□ 170	Q15	125	175	4000 K	DALI	2370 lm/28 W	AZ-2554-12-40
	□ 207	□ 200	Q18	125	175	3000 K	DALI	2550 lm/28 W	AZ-2564-12-30
	□ 207	□ 200	Q18	125	175	4000 K	DALI	2700 lm/28 W	AZ-2564-12-40

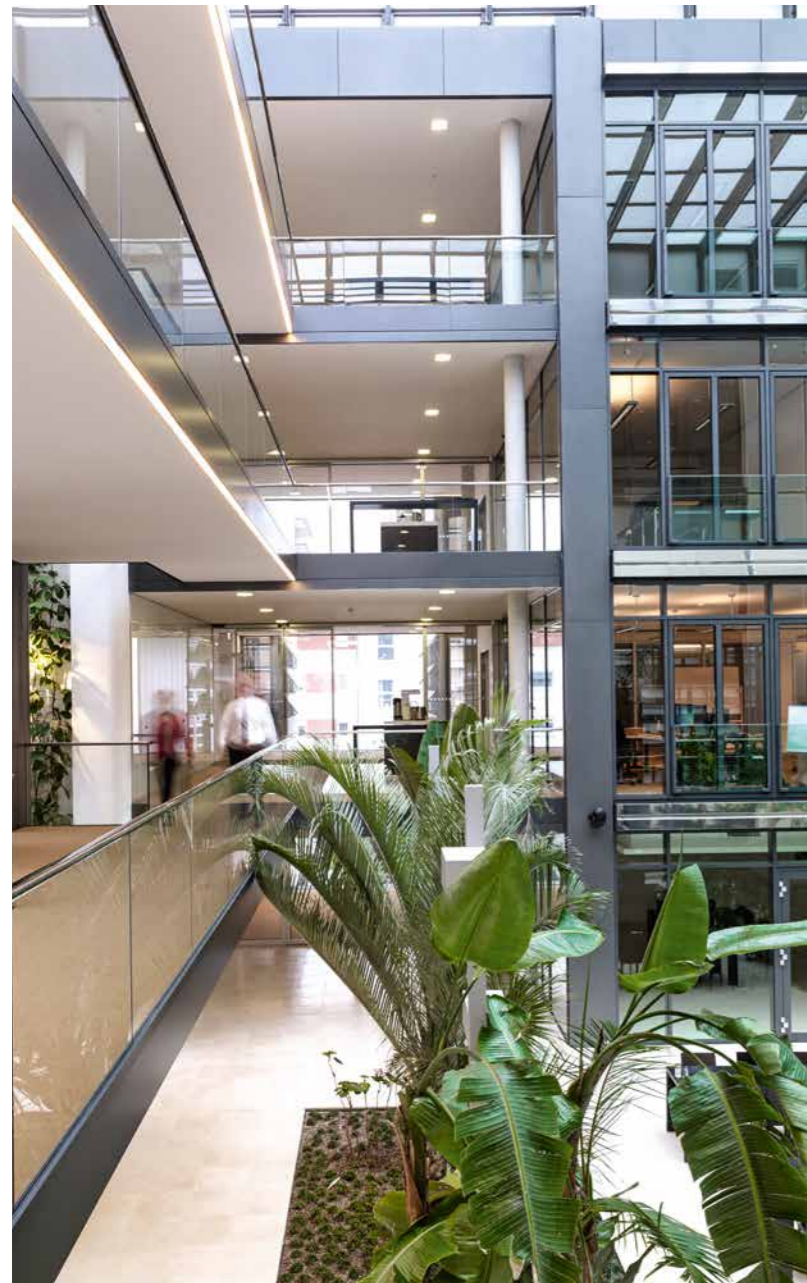

REDUZIERTE EINBAUTIEFE

Klimakanäle, Sprinklerrohre oder Unterzüge limitieren häufig die Einbautiefe in abgehängten Decken. In diesen Einsatzbereichen sind die Spezialisten der Produktfamilie ALPHABET ZONO mit nur 49 mm Einbautiefe der optimale Problemlöser.

REDUCED RECESSED DEPTH

Air-conditioning ducts or sprinkler systems very often limit the recess depth in suspended ceiling systems. The special designs in the ALPHABET ZONO range with only 49 mm recessed depth, are the ideal problem solver.



Baader Bank Unterschleißheim | Architekturbüro Baader, Gräfeling | Ingenieurbüro Pfeuffer, München | Foto H.-J. Krumnow

SCHUTZART IP54 UND INSEKTENDICHT

Aufgrund des abgekapselten Reflektorraumes und des lichtdichten Gehäuses liegen keine Insekten auf dem unteren Abschlussglas, dies garantiert eine konstante Lichtverteilung bei gleichbleibenden Wirkungsgraden, reduziert die Wartung und sorgt für ein sauberes Deckenbild.

PROTECTION TYPE IP54 AND INSECT-PROOF

Due to the encapsulated reflector chamber and the light-proof housing, there are no insects on the lower cover screen. This guarantees a constant light distribution, reduces maintenance and provides a clear ceiling appearance.





TENTEC 3

FUNKTIONALE LICHTLÖSUNGEN
ZUR GRUNDBELEUCHTUNG UND
AKZENTUIERUNG

- DA 95/120 mm (vormals TENTEC ACCENT)
- DA 165/195 mm
- Formstabiles Leuchtgehäuse
- Hohe Farbwiedergabe CRI > 90
- Ballwurfsichere Version
- Betonarmaturen zur einfachen Montage auf Anfrage

FUNCTIONAL LIGHTING SOLUTIONS
FOR GENERAL LIGHTING AND
ACCENTUATION

- CO 95/120 mm (before TENTEC ACCENT)
- CO 165/195 mm
- Stable housing design
- High colour rendering CRI > 90
- Ball-proof version
- Concrete mounting boxes on request



TENTEC 3 Downlights

DOWNLIGHT	D	DA CO	R	H	ET RD	CCT	Treiber	Leistung	UGR <19	CRI >90	3000K	4000K	DALI	ON OFF	IP20	Art.-Nr. Item No.
Reflektor hochglanz silber	mm	mm		mm	mm		Driver	Wattage								
Reflector highpolished silver																



102	95	R08	80	100	3000 K	ON/OFF	890 lm / 7 W									504-1121-10-30
102	95	R08	80	100	4000 K	ON/OFF	930 lm / 7 W									504-1121-10-40
102	95	R08	80	100	3000 K	DALI	890 lm / 7 W									504-1121-12-30
102	95	R08	80	100	4000 K	DALI	930 lm / 7 W									504-1121-12-40
102	95	R08	80	100	3000 K	ON/OFF	1650 lm/13 W									504-1123-10-30
102	95	R08	80	100	4000 K	ON/OFF	1700 lm/13 W									504-1123-10-40
102	95	R08	80	100	3000 K	DALI	1650 lm/13 W									504-1123-12-30
102	95	R08	80	100	4000 K	DALI	1700 lm/13 W									504-1123-12-40
127	120	R10	102	120	3000 K	ON/OFF	920 lm / 7 W									504-1131-10-30
127	120	R10	102	120	4000 K	ON/OFF	960 lm / 7 W									504-1131-10-40
127	120	R10	102	120	3000 K	DALI	920 lm / 7 W									504-1131-12-30
127	120	R10	102	120	4000 K	DALI	960 lm / 7 W									504-1131-12-40
127	120	R10	102	120	3000 K	ON/OFF	1720 lm/13 W									504-1133-10-30
127	120	R10	102	120	4000 K	ON/OFF	1770 lm/13 W									504-1133-10-40
127	120	R10	102	120	3000 K	DALI	1720 lm/13 W									504-1133-12-30
127	120	R10	102	120	4000 K	DALI	1770 lm/13 W									504-1133-12-40
127	120	R10	102	120	3000 K	ON/OFF	2390 lm/19 W									504-1134-10-30
127	120	R10	102	120	4000 K	ON/OFF	2460 lm/19 W									504-1134-10-40
127	120	R10	102	120	3000 K	DALI	2390 lm/19 W									504-1134-12-30
127	120	R10	102	120	4000 K	DALI	2460 lm/19 W									504-1134-12-40
172	165	R15	93	115	3000 K	ON/OFF	1337 lm / 9 W									504-1152-10-30
172	165	R15	93	115	4000 K	ON/OFF	1370 lm / 9 W									504-1152-10-40
172	165	R15	93	115	3000 K	DALI	1337 lm / 9 W									504-1152-12-30
172	165	R15	93	115	4000 K	DALI	1370 lm / 9 W									504-1152-12-40
172	165	R15	93	115	3000 K	ON/OFF	1800 lm/13 W									504-1153-10-30
172	165	R15	93	115	4000 K	ON/OFF	1860 lm/13 W									504-1153-10-40
172	165	R15	93	115	3000 K	DALI	1800 lm/13 W									504-1153-12-30
172	165	R15	93	115	4000 K	DALI	1860 lm/13 W									504-1153-12-40
172	165	R15	93	115	3000 K	ON/OFF	2500 lm/19 W									504-1154-10-30
172	165	R15	93	115	4000 K	ON/OFF	2580 lm/19 W									504-1154-10-40
172	165	R15	93	115	3000 K	DALI	2500 lm/19 W									504-1154-12-30
172	165	R15	93	115	4000 K	DALI	2580 lm/19 W									504-1154-12-40
202	195	R18	112	115	3000 K	ON/OFF	1820 lm/13 W									504-1163-10-30
202	195	R18	112	115	4000 K	ON/OFF	1870 lm/13 W									504-1163-10-40
202	195	R18	112	115	3000 K	DALI	1820 lm/13 W									504-1163-12-30
202	195	R18	112	115	4000 K	DALI	1870 lm/13 W									504-1163-12-40
202	195	R18	112	115	3000 K	ON/OFF	2510 lm/19 W									504-1164-10-30
202	195	R18	112	115	4000 K	ON/OFF	2580 lm/19 W									504-1164-10-40
202	195	R18	112	115	3000 K	DALI	2510 lm/19 W									504-1164-12-30
202	195	R18	112	115	4000 K	DALI	2580 lm/19 W									504-1164-12-40
202	195	R18	112	115	3000 K	ON/OFF	3350 lm/27 W									504-1165-10-30
202	195	R18	112	115	4000 K	ON/OFF	3450 lm/27 W									504-1165-10-40
202	195	R18	112	115	3000 K	DALI	3350 lm/27 W									504-1165-12-30
202	195	R18	112	115	4000 K	DALI	3450 lm/27 W									504-1165-12-40
202	195	R18	112	140	3000 K	ON/OFF	4610 lm/41 W									504-1166-10-30
202	195	R18	112	140	4000 K	ON/OFF	4750 lm/41 W									504-1166-10-40
202	195	R18	112	140	3000 K	DALI	4610 lm/41 W									504-1166-12-30
202	195	R18	112	140	4000 K	DALI	4750 lm/41 W									504-1166-12-40

Variante | Version
TENTEC 3

TunableWhite
(nur|only DALI)

RAL nach Wahl|of choice

Steuerung|Control

Treiber|Driver

Notlicht|Emergency 3h

Weitere Notlicht-Varianten auf Anfrage
Emergency lighting variants on request



TENTEC 3 Downlights

DOWNLIGHT Streuscheibe Diffusing screen	D mm	DA CO mm	R	H mm	ET RD mm	CCT	Treiber Driver	Leistung Wattage	Art.-Nr. Item No.
---	---------	-------------	---	---------	-------------	-----	-------------------	---------------------	-------------------

	102	95	R08	80	100	3000 K	ON/OFF	780 lm / 7 W	504-1421-10-30
	102	95	R08	80	100	4000 K	ON/OFF	820 lm / 7 W	504-1421-10-40
	102	95	R08	80	100	3000 K	DALI	780 lm / 7 W	504-1421-12-30
	102	95	R08	80	100	4000 K	DALI	820 lm / 7 W	504-1421-12-40
	102	95	R08	80	100	3000 K	ON/OFF	1460 lm/13 W	504-1423-10-30
	102	95	R08	80	100	4000 K	ON/OFF	1500 lm/13 W	504-1423-10-40
	102	95	R08	80	100	3000 K	DALI	1460 lm/13 W	504-1423-12-30
	102	95	R08	80	100	4000 K	DALI	1500 lm/13 W	504-1423-12-40
	127	120	R10	102	120	3000 K	ON/OFF	820 lm / 7 W	504-1431-10-30
	127	120	R10	102	120	4000 K	ON/OFF	850 lm / 7 W	504-1431-10-40
	127	120	R10	102	120	3000 K	DALI	820 lm / 7 W	504-1431-12-30
	127	120	R10	102	120	4000 K	DALI	850 lm / 7 W	504-1431-12-40
	127	120	R10	102	120	3000 K	ON/OFF	1460 lm/13 W	504-1433-10-30
	127	120	R10	102	120	4000 K	ON/OFF	1570 lm/13 W	504-1433-10-40
	127	120	R10	102	120	3000 K	DALI	1460 lm/13 W	504-1433-12-30
	127	120	R10	102	120	4000 K	DALI	1570 lm/13 W	504-1433-12-40
	127	120	R10	102	120	3000 K	ON/OFF	2110 lm/19 W	504-1434-10-30
	127	120	R10	102	120	4000 K	ON/OFF	2180 lm/19 W	504-1434-10-40
	127	120	R10	102	120	3000 K	DALI	2110 lm/19 W	504-1434-12-30
	127	120	R10	102	120	4000 K	DALI	2180 lm/19 W	504-1434-12-40
	172	165	R15	93	115	3000 K	ON/OFF	1120 lm / 9 W	504-1452-10-30
	172	165	R15	93	115	4000 K	ON/OFF	1160 lm / 9 W	504-1452-10-40
	172	165	R15	93	115	3000 K	DALI	1120 lm / 9 W	504-1452-12-30
	172	165	R15	93	115	4000 K	DALI	1160 lm / 9 W	504-1452-12-40
	172	165	R15	93	115	3000 K	ON/OFF	1530 lm/13 W	504-1453-10-30
	172	165	R15	93	115	4000 K	ON/OFF	1570 lm/13 W	504-1453-10-40
	172	165	R15	93	115	3000 K	DALI	1530 lm/13 W	504-1453-12-30
	172	165	R15	93	115	4000 K	DALI	1570 lm/13 W	504-1453-12-40
	172	165	R15	93	115	3000 K	ON/OFF	2110 lm/19 W	504-1454-10-30
	172	165	R15	93	115	4000 K	ON/OFF	2180 lm/19 W	504-1454-10-40
	172	165	R15	93	115	3000 K	DALI	2110 lm/19 W	504-1454-12-30
	172	165	R15	93	115	4000 K	DALI	2180 lm/19 W	504-1454-12-40
	202	195	R18	112	115	3000 K	ON/OFF	1530 lm/13 W	504-1463-10-30
	202	195	R18	112	115	4000 K	ON/OFF	1570 lm/13 W	504-1463-10-40
	202	195	R18	112	115	3000 K	DALI	1530 lm/13 W	504-1463-12-30
	202	195	R18	112	115	4000 K	DALI	1570 lm/13 W	504-1463-12-40
	202	195	R18	112	115	3000 K	ON/OFF	2110 lm/19 W	504-1464-10-30
	202	195	R18	112	115	4000 K	ON/OFF	2180 lm/19 W	504-1464-10-40
	202	195	R18	112	115	3000 K	DALI	2110 lm/19 W	504-1464-12-30
	202	195	R18	112	115	4000 K	DALI	2180 lm/19 W	504-1464-12-40
	202	195	R18	112	115	3000 K	ON/OFF	2850 lm/27 W	504-1465-10-30
	202	195	R18	112	115	4000 K	ON/OFF	2930 lm/27 W	504-1465-10-40
	202	195	R18	112	115	3000 K	DALI	2850 lm/27 W	504-1465-12-30
	202	195	R18	112	115	4000 K	DALI	2930 lm/27 W	504-1465-12-40
	202	195	R18	112	140	3000 K	ON/OFF	3930 lm/42 W	504-1466-10-30
	202	195	R18	112	140	4000 K	ON/OFF	4080 lm/42 W	504-1466-10-40
	202	195	R18	112	140	3000 K	DALI	3930 lm/42 W	504-1466-12-30
	202	195	R18	112	140	4000 K	DALI	4080 lm/42 W	504-1466-12-40



TENTEC 3 Downlights

DOWNLIGHT Schutzscheibe Safety screen	D mm	DA CO mm	R	H mm	ET RD mm	CCT	Treiber Driver	Leistung Wattage	Art.-Nr. Item No.
---	---------	-------------	---	---------	-------------	-----	-------------------	---------------------	-------------------

	102	95	R08	80	100	3000 K	ON/OFF	830 lm / 7 W	504-1621-10-30
	102	95	R08	80	100	4000 K	ON/OFF	870 lm / 7 W	504-1621-10-40
	102	95	R08	80	100	3000 K	DALI	830 lm / 7 W	504-1621-12-30
	102	95	R08	80	100	4000 K	DALI	870 lm / 7 W	504-1621-12-40
	102	95	R08	80	100	3000 K	ON/OFF	1550 lm/13 W	504-1623-10-30
	102	95	R08	80	100	4000 K	ON/OFF	1590 lm/13 W	504-1623-10-40
	102	95	R08	80	100	3000 K	DALI	1550 lm/13 W	504-1623-12-30
	102	95	R08	80	100	4000 K	DALI	1590 lm/13 W	504-1623-12-40
	127	120	R10	102	120	3000 K	ON/OFF	860 lm / 7 W	504-1631-10-30
	127	120	R10	102	120	4000 K	ON/OFF	900 lm / 7 W	504-1631-10-40
	127	120	R10	102	120	3000 K	DALI	860 lm / 7 W	504-1631-12-30
	127	120	R10	102	120	4000 K	DALI	900 lm / 7 W	504-1631-12-40
	127	120	R10	102	120	3000 K	ON/OFF	1610 lm/13 W	504-1633-10-30
	127	120	R10	102	120	4000 K	ON/OFF	1660 lm/13 W	504-1633-10-40
	127	120	R10	102	120	3000 K	DALI	1610 lm/13 W	504-1633-12-30
	127	120	R10	102	120	4000 K	DALI	1660 lm/13 W	504-1633-12-40
	127	120	R10	102	120	3000 K	ON/OFF	2230 lm/19 W	504-1634-10-30
	127	120	R10	102	120	4000 K	ON/OFF	2300 lm/19 W	504-1634-10-40
	127	120	R10	102	120	3000 K	DALI	2230 lm/19 W	504-1634-12-30
	127	120	R10	102	120	4000 K	DALI	2300 lm/19 W	504-1634-12-40
	172	165	R15	93	115	3000 K	ON/OFF	1230 lm / 9 W	504-1652-10-30
	172	165	R15	93	115	4000 K	ON/OFF	1270 lm / 9 W	504-1652-10-40
	172	165	R15	93	115	3000 K	DALI	1230 lm / 9 W	504-1652-12-30
	172	165	R15	93	115	4000 K	DALI	1270 lm / 9 W	504-1652-12-40
	172	165	R15	93	115	3000 K	ON/OFF	1680 lm/13 W	504-1653-10-30
	172	165	R15	93	115	4000 K	ON/OFF	1720 lm/13 W	504-1653-10-40
	172	165	R15	93	115	3000 K	DALI	1680 lm/13 W	504-1653-12-30
	172	165	R15	93	115	4000 K	DALI	1720 lm/13 W	504-1653-12-40
	172	165	R15	93	115	3000 K	ON/OFF	2320 lm/19 W	504-1654-10-30
	172	165	R15	93	115	4000 K	ON/OFF	2400 lm/19 W	504-1654-10-40
	172	165	R15	93	115	3000 K	DALI	2320 lm/19 W	504-1654-12-30
	172	165	R15	93	115	4000 K	DALI	2400 lm/19 W	504-1654-12-40
	202	195	R18	112	115	3000 K	ON/OFF	1680 lm/13 W	504-1663-10-30
	202	195	R18	112	115	4000 K	ON/OFF	1720 lm/13 W	504-1663-10-40
	202	195	R18	112	115	3000 K	DALI	1680 lm/13 W	504-1663-12-30
	202	195	R18	112	115	4000 K	DALI	1720 lm/13 W	504-1663-12-40
	202	195	R18	112	115	3000 K	ON/OFF	2320 lm/19 W	504-1664-10-30
	202	195	R18	112	115	4000 K	ON/OFF	2400 lm/19 W	504-1664-10-40
	202	195	R18	112	115	3000 K	DALI	2320 lm/19 W	504-1664-12-30
	202	195	R18	112	115	4000 K	DALI	2400 lm/19 W	504-1664-12-40
	202	195	R18	112	115	3000 K	ON/OFF	3130 lm/27 W	504-1665-10-30
	202	195	R18	112	115	4000 K	ON/OFF	3220 lm/27 W	504-1665-10-40
	202	195	R18	112	115	3000 K	DALI	3130 lm/27 W	504-1665-12-30
	202	195	R18	112	115	4000 K	DALI	3220 lm/27 W	504-1665-12-40
	202	195	R18	112	140	3000 K	ON/OFF	4350 lm/42 W	504-1666-10-30
	202	195	R18	112	140	4000 K	ON/OFF	4480 lm/42 W	504-1666-10-40
	202	195	R18	112	140	3000 K	DALI	4350 lm/42 W	504-1666-12-30
	202	195	R18	112	140	4000 K	DALI	4480 lm/42 W	504-1666-12-40



BALLWURFSICHER | BALL-PROOF

GEPRÜFTE QUALITÄT

Ballwurfsichere, nach DIN VDE 0710-13 geprüfte LED-Einbauleuchte mit PMMA-Abdeckscheibe. Geeignet zum Einsatz in Sportstätten nach DIN 18032-3.

Es kann so einfach sein! Der Ring (1) wird über die Leuchte gestülpt und auf den Montagering gelegt. Wie gewohnt wird die Leuchte in die Decke eingesetzt, festgeschraubt, der Reflektor eingesetzt. Nun wird die ballwurfsichere Scheibe (2) aufgesetzt und einfach festgeschraubt!

TESTED QUALITY

Ball-proof, DIN VDE 0710-13-tested recessed mounted LED luminaire with PMMA cover lens. Suitable for use in sports facilities according to DIN 18032-3.

It can be that simple! The ring (1) is slipped over the luminaire and placed on the mounting ring. As usual, the luminaire is inserted into the ceiling, screwed on and the reflector inserted. Now the ball-proof disc (2) is put on and simply screwed on!

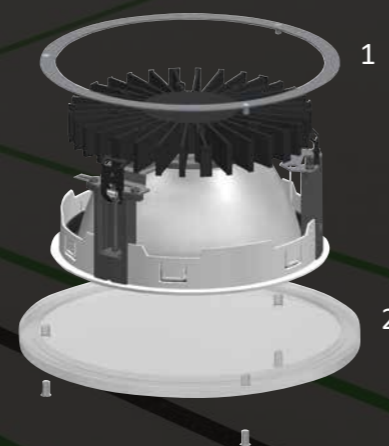

TENTEC 3 Downlights

DOWNLIGHT

Schutzscheibe, ballwurfsicher
Safety screen, ball-proof

D DA|CO R H ET|RD CCT Treiber Leistung
mm mm mm mm mm CCT Driver Wattage



Art.-Nr. | Item No.

klar | clear

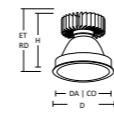

210	165	R15	93	115	3000 K	ON/OFF	1169 lm / 9 W	504-1152-10-30 + 504-801-156
210	165	R15	93	115	4000 K	ON/OFF	1169 lm / 9 W	504-1152-10-40 + 504-801-156
210	165	R15	93	115	3000 K	DALI	1205 lm / 9 W	504-1152-12-30 + 504-801-156
210	165	R15	93	115	4000 K	DALI	1205 lm / 9 W	504-1152-12-40 + 504-801-156
210	165	R15	93	115	3000 K	ON/OFF	1586 lm/13 W	504-1153-10-30 + 504-801-156
210	165	R15	93	115	4000 K	ON/OFF	1586 lm/13 W	504-1153-10-40 + 504-801-156
210	165	R15	93	115	3000 K	DALI	1635 lm/13 W	504-1153-12-30 + 504-801-156
210	165	R15	93	115	4000 K	DALI	1635 lm/13 W	504-1153-12-40 + 504-801-156
210	165	R15	93	115	3000 K	ON/OFF	2212 lm/19 W	504-1154-10-30 + 504-801-156
210	165	R15	93	115	4000 K	ON/OFF	2212 lm/19 W	504-1154-10-40 + 504-801-156
210	165	R15	93	115	3000 K	DALI	2280 lm/19 W	504-1154-12-30 + 504-801-156
210	165	R15	93	115	4000 K	DALI	2280 lm/19 W	504-1154-12-40 + 504-801-156
240	195	R18	112	115	3000 K	ON/OFF	1586 lm/13 W	504-1163-10-30 + 504-801-186
240	195	R18	112	115	4000 K	ON/OFF	1586 lm/13 W	504-1163-10-40 + 504-801-186
240	195	R18	112	115	3000 K	DALI	1635 lm/13 W	504-1163-12-30 + 504-801-186
240	195	R18	112	115	4000 K	DALI	1635 lm/13 W	504-1163-12-40 + 504-801-186
240	195	R18	112	115	3000 K	ON/OFF	2212 lm/19 W	504-1164-10-30 + 504-801-186
240	195	R18	112	115	4000 K	ON/OFF	2212 lm/19 W	504-1164-10-40 + 504-801-186
240	195	R18	112	115	3000 K	DALI	2280 lm/19 W	504-1164-12-30 + 504-801-186
240	195	R18	112	115	4000 K	DALI	2280 lm/19 W	504-1164-12-40 + 504-801-186
240	195	R18	112	115	3000 K	ON/OFF	2968 lm/27 W	504-1165-10-30 + 504-801-186
240	195	R18	112	115	4000 K	ON/OFF	2968 lm/27 W	504-1165-10-40 + 504-801-186
240	195	R18	112	115	3000 K	DALI	3060 lm/27 W	504-1165-12-30 + 504-801-186
240	195	R18	112	115	4000 K	DALI	3060 lm/27 W	504-1165-12-40 + 504-801-186
240	195	R18	112	140	3000 K	ON/OFF	4132 lm/42 W	504-1166-10-30 + 504-801-186
240	195	R18	112	140	4000 K	ON/OFF	4132 lm/42 W	504-1166-10-40 + 504-801-186
240	195	R18	112	140	3000 K	DALI	4260 lm/42 W	504-1166-12-30 + 504-801-186
240	195	R18	112	140	4000 K	DALI	4260 lm/42 W	504-1166-12-40 + 504-801-186

matt | frosted

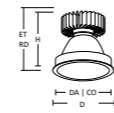

210	165	R15	93	115	3000 K	ON/OFF	1067 lm / 9 W	504-1152-10-30 + 504-801-154
210	165	R15	93	115	4000 K	ON/OFF	1067 lm / 9 W	504-1152-10-40 + 504-801-154
210	165	R15	93	115	3000 K	DALI	1100 lm / 9 W	504-1152-12-30 + 504-801-154
210	165	R15	93	115	4000 K	DALI	1100 lm / 9 W	504-1152-12-40 + 504-801-154
210	165	R15	93	115	3000 K	ON/OFF	1445 lm/13 W	504-1153-10-30 + 504-801-154
210	165	R15	93	115	4000 K	ON/OFF	1445 lm/13 W	504-1153-10-40 + 504-801-154
210	165	R15	93	115	3000 K	DALI	1490 lm/13 W	504-1153-12-30 + 504-801-154
210	165	R15	93	115	4000 K	DALI	1490 lm/13 W	504-1153-12-40 + 504-801-154
210	165	R15	93	115	3000 K	ON/OFF	2008 lm/19 W	504-1154-10-30 + 504-801-154
210	165	R15	93	115	4000 K	ON/OFF	2008 lm/19 W	504-1154-10-40 + 504-801-154
210	165	R15	93	115	3000 K	DALI	2070 lm/19 W	504-1154-12-30 + 504-801-154
210	165	R15	93	115	4000 K	DALI	2070 lm/19 W	504-1154-12-40 + 504-801-154
240	195	R18	112	115	3000 K	ON/OFF	1445 lm/13 W	504-1163-10-30 + 504-801-184
240	195	R18	112	115	4000 K	ON/OFF	1445 lm/13 W	504-1163-10-40 + 504-801-184
240	195	R18	112	115	3000 K	DALI	1490 lm/13 W	504-1163-12-30 + 504-801-184
240	195	R18	112	115	4000 K	DALI	1490 lm/13 W	504-1163-12-40 + 504-801-184
240	195	R18	112	115	3000 K	ON/OFF	2008 lm/19 W	504-1164-10-30 + 504-801-184
240	195	R18	112	115	4000 K	ON/OFF	2008 lm/19 W	504-1164-10-40 + 504-801-184
240	195	R18	112	115	3000 K	DALI	2070 lm/19 W	504-1164-12-30 + 504-801-184
240	195	R18	112	115	4000 K	DALI	2070 lm/19 W	504-1164-12-40 + 504-801-184
240	195	R18	112	115	3000 K	ON/OFF	2701 lm/27 W	504-1165-10-30 + 504-801-184
240	195	R18	112	115	4000 K	ON/OFF	2701 lm/27 W	504-1165-10-40 + 504-801-184
240	195	R18	112	115	3000 K	DALI	2785 lm/27 W	504-1165-12-30 + 504-801-184
240	195	R18	112	115	4000 K	DALI	2785 lm/27 W	504-1165-12-40 + 504-801-184
240	195	R18	112	140	3000 K	ON/OFF	3764 lm/42 W	504-1166-10-30 + 504-801-184
240	195	R18	112	140	4000 K	ON/OFF	3764 lm/42 W	504-1166-10-40 + 504-801-184
240	195	R18	112	140	3000 K	DALI	3880 lm/42 W	504-1166-12-30 + 504-801-184
240	195	R18	112	140	4000 K	DALI	3880 lm/42 W	504-1166-12-40 + 504-801-184



TENTEC FLAT

DER FAIRE EINSTIEG IN DIE GRUNDBELEUCHTUNG

- Universelles Beleuchtungswerkzeug für allgemeine Beleuchtungsaufgaben
- Sehr geringe Einbautiefe
- Effiziente und gleichmäßige Lichtverteilung
- Erhöhte Schutzart IP44 in geschlossenen Deckensystemen

THE FAIR APPROACH TO GENERAL LIGHTING

- Universal lighting tool for general illumination tasks
- Very low installation depth
- Efficient and uniform light distribution
- Increased protection class IP44 in closed ceiling systems

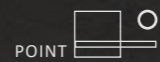

TENTEC FLAT Downlights

DOWNLIGHT Streuscheibe Diffusing screen	D mm	DA CO mm	R	H mm	ET RD mm	CCT	Treiber Driver	Leistung Wattage	Art.-Nr. Item No.
	o 172	o 165	R15	52	60	3000 K	ON/OFF	1130 lm / 9 W	502-1452-10-30
	o 172	o 165	R15	52	60	4000 K	ON/OFF	1170 lm / 9 W	502-1452-10-40
	o 172	o 165	R15	52	60	3000 K	DALI	1130 lm / 9 W	502-1452-12-30
	o 172	o 165	R15	52	60	4000 K	DALI	1170 lm / 9 W	502-1452-12-40
	o 172	o 165	R15	52	60	3000 K	ON/OFF	1530 lm/13 W	502-1453-10-30
	o 172	o 165	R15	52	60	4000 K	ON/OFF	1580 lm/13 W	502-1453-10-40
	o 172	o 165	R15	52	60	3000 K	DALI	1530 lm/13 W	502-1453-12-30
	o 172	o 165	R15	52	60	4000 K	DALI	1580 lm/13 W	502-1453-12-40
	o 172	o 165	R15	52	60	3000 K	ON/OFF	2100 lm/19 W	502-1454-10-30
	o 172	o 165	R15	52	60	4000 K	ON/OFF	2170 lm/19 W	502-1454-10-40
	o 172	o 165	R15	52	60	3000 K	DALI	2100 lm/19 W	502-1454-12-30
	o 172	o 165	R15	52	60	4000 K	DALI	2170 lm/19 W	502-1454-12-40

Variante | Version
TENTEC FLAT

CASAMBI Steuerung | Control

1-10V Treiber | Driver



Diffuse Lichtoptik zurückversetzt im Leuchtgehäuse, Kühlkörper aus Graphen für beste Wärmeleitfähigkeit und reduziertes Gewicht.

Diffuse optic, comfortably sitting back inside the housing, heat sink made of graphene for best thermal conductivity and reduced weight.



I
n
d
e
x



TENTEC ZONO

WIRTSCHAFTLICHE ALLGEMEIN-BELEUCHTUNG

- Neueste LED-Technologie
- Hohe Farbwiedergabe CRI > 90
- Blendungsbegrenzung für Bildschirm-anwendungen der höchsten Kategorie
- Geringe Einbautiefe, ideal bei Deckenrestriktionen
- MS-3 Montagetechnik zum werkzeug-losen Wechsel von Lichtoptiken
- Integrierte Diffusorkalotte für homogene Lichtverteilung

ECONOMIC GENERAL LIGHTING

- Latest LED technology
- High colour rendering CRI > 90
- Precise glare control suitable for VDU applications of the highest category
- Low installation depth, ideal for restricted ceiling space
- MS-3 mounting for toolless exchange of light optics
- Integrated diffuser cap for homogeneous light distribution



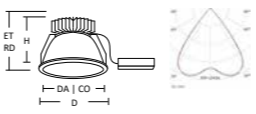

Gymnasium Grünwald, München | Licht & Design Hubert Saegmüller, Starnberg | BKS Bauer, Kurz, Stockburger & Partner, München | IB Knab, München | Foto Eberhard Franke, München

TENTEC ZONO Downlights

DOWNLIGHT Reflektor seidenmatt Reflector matt	D mm	DA CO mm	R	H mm	ET RD mm	CCT	Treiber Driver	Leistung Wattage	UGR < 19 CRI > 90 3000K 4000K DALI ON/OFF IP20	Art.-Nr. Item No.
	180	165	R15	115	160	3000 K	ON/OFF	1280 lm / 9 W		TL-1151-10-30
	180	165	R15	115	160	4000 K	ON/OFF	1310 lm / 9 W		TL-1151-10-40
	180	165	R15	115	160	3000 K	DALI	1280 lm / 9 W		TL-1151-12-30
	180	165	R15	115	160	4000 K	DALI	1310 lm / 9 W		TL-1151-12-40
	180	165	R15	115	160	3000 K	ON/OFF	1750 lm/13 W		TL-1152-10-30
	180	165	R15	115	160	4000 K	ON/OFF	1800 lm/13 W		TL-1152-10-40
	180	165	R15	115	160	3000 K	DALI	1750 lm/13 W		TL-1152-12-30
	180	165	R15	115	160	4000 K	DALI	1800 lm/13 W		TL-1152-12-40
	180	165	R15	115	160	3000 K	ON/OFF	2420 lm/19 W		TL-1153-10-30
	180	165	R15	115	160	4000 K	ON/OFF	2490 lm/19 W		TL-1153-10-40
	180	165	R15	115	160	3000 K	DALI	2420 lm/19 W		TL-1153-12-30
	180	165	R15	115	160	4000 K	DALI	2490 lm/19 W		TL-1153-12-40
	210	195	R18	115	160	3000 K	ON/OFF	1820 lm/13 W		TL-1162-10-30
	210	195	R18	115	160	4000 K	ON/OFF	1870 lm/13 W		TL-1162-10-40
	210	195	R18	115	160	3000 K	DALI	1820 lm/13 W		TL-1162-12-30
	210	195	R18	115	160	4000 K	DALI	1870 lm/13 W		TL-1162-12-40
	210	195	R18	115	160	3000 K	ON/OFF	2510 lm/19 W		TL-1163-10-30
	210	195	R18	115	160	4000 K	ON/OFF	2580 lm/19 W		TL-1163-10-40
	210	195	R18	115	160	3000 K	DALI	2510 lm/19 W		TL-1163-12-30
	210	195	R18	115	160	4000 K	DALI	2580 lm/19 W		TL-1163-12-40
	210	195	R18	115	160	3000 K	ON/OFF	3350 lm/27 W		TL-1164-10-30
	210	195	R18	115	160	4000 K	ON/OFF	3450 lm/27 W		TL-1164-10-40
	210	195	R18	115	160	3000 K	DALI	3350 lm/27 W		TL-1164-12-30
	210	195	R18	115	160	4000 K	DALI	3450 lm/27 W		TL-1164-12-40
	210	195	R18	115	160	3000 K	ON/OFF	4610 lm/41 W		TL-1165-10-30
	210	195	R18	115	160	4000 K	ON/OFF	4750 lm/41 W		TL-1165-10-40
	210	195	R18	115	160	3000 K	DALI	4610 lm/41 W		TL-1165-12-30
	210	195	R18	115	160	4000 K	DALI	4750 lm/41 W		TL-1165-12-40

Variante | Version
TENTEC ZONO

 TunableWhite
(nur | only DALI)

 RAL nach Wahl | of choice

 Steuerung | Control

 Treiber | Driver

 Notlicht | Emergency 3h

Weitere Notlicht-Varianten auf Anfrage
Emergency lighting variants on request

BMW BECKER-TIEMANN, STADTHAGEN

Mittelpunkt der Ausstellungsfläche ist die sogenannte „Road“, auf der BMW Fahrzeuge dynamisch präsentiert werden. Um für eine perfekte Farbwiedergabe der Fahrzeuge zu sorgen wurde auf einen hohen CRI-Wert geachtet. Dies gibt dem Kunden zusätzlich Sicherheit bei seiner Kaufentscheidung, da Farbverfälschungen gerade im Rot-Bereich durch LEDs so vermieden werden.

The centrepiece of the exhibition area is the so-called 'Road', on which the BMW vehicles are presented dynamically. In order to ensure perfect colour rendering of the vehicles a high CRI value was chosen. This gives the customer additional security when making a purchase decision, as colour distortions caused by LEDs, particularly in the red range, are avoided.



Homeier & Partner Solution Technology (HST), Nienstädt | Foto WILA



TENTEC ZONO Downlights

Table with columns: D, DA|CO, R, H, ET|RD, CCT, Treiber, Leistung, and Art.-Nr.|Item No. for Downlight Diffusing screen. Includes technical diagrams of the light fixture.

DOWNLIGHT Schutzscheibe | Safety screen. Includes icons for UGR, CRI, CCT, DALI, ON/OFF, and IP44.

Table with columns: D, DA|CO, R, H, ET|RD, CCT, Treiber, Leistung, and Art.-Nr.|Item No. for Downlight Safety screen. Includes technical diagrams of the light fixture.

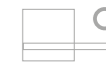

TENTEC ZONO Downlights

Table with columns: D, DA|CO, R, H, ET|RD, CCT, Treiber, Leistung, and Art.-Nr.|Item No. for Downlight Corona H 20 mm. Includes technical diagrams of the light fixture.

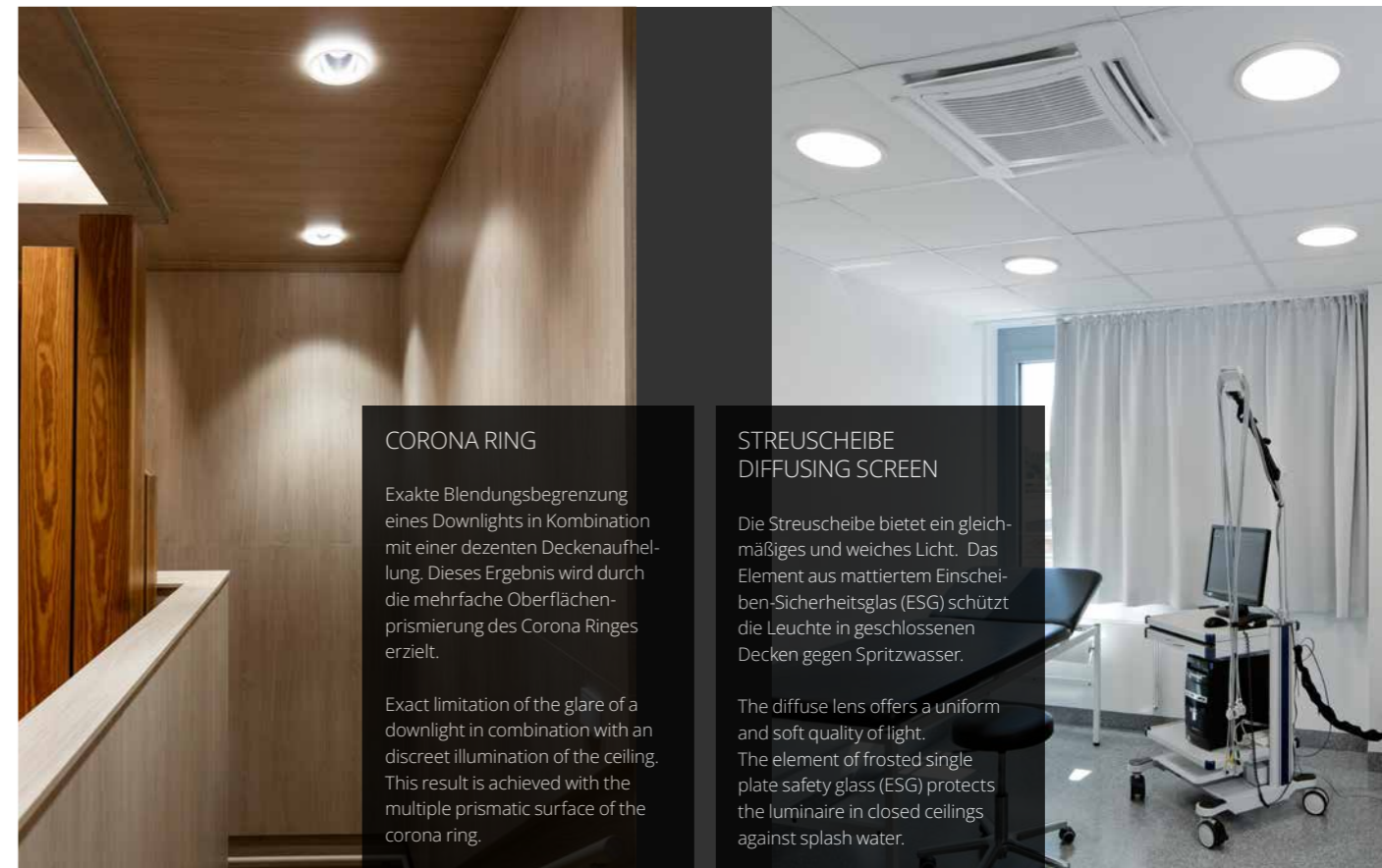

Locations and project names: Sophie-Barat-Schule, Hamburg; Haslob, Kruse und Partner, Bremen; IWP Ingenieure, Schaller Warnke Peters, Elmshorn; Fritsche Elektrotechnik, Norderstedt; Markus Krankenhaus, Frankfurt; Stefan Ludes Architekten, Berlin; PWB Planungsbüro, Oberursel; Foto Werner Huthmacher, Berlin.



TENTEC SL

EINFACHER WECHSEL ZU EFFIZIENTEN LICHTSYSTEMEN

Modernste LED-Downlights ohne aufwendige Deckensanierung

- Integrierte Diffusorkalotte zur homogenen Lichtverteilung
- Farbstabilität < 2-step MacAdams
- Hohe Farbwiedergabe CRI > 90
- Stabiles Gehäuse aus Aluminium-Druckguss, passives Temperaturmanagement
- Sichere Montage, 3-Punkt-Schraubbefestigung, MS-3 Montagetechnik zum werkzeuglosen Wechsel von Lichtoptiken

EASY SWITCH TO EFFICIENT LIGHTING SYSTEMS

State-of-the-art LED downlights without extensive refurbishment

- Integrated diffuser cap for homogeneous light distribution
- Colour consistency < 2 step MacAdams
- High colour rendering CRI > 90
- Robust aluminium die casting housing, passive temperature management
- Safe assembly, threaded 3-point screw fixing, MS-3 mounting technique for a toolless change of light optics



TENTEC SL Komplettleuchte | Complete luminaire

DOWNLIGHT
mit Schnellmontagering
with quick mounting ring

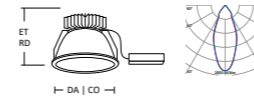

ERSATZ REPLACEMENT	R	DA CO mm	ET RD mm	Effizienz lm/W	CCT	Treiber Driver	Leistung Wattage	Art.-Nr. Item No.
--------------------	---	----------	----------	----------------	-----	----------------	------------------	---------------------

TC-TEL(I)

2 x 18 W	R23	240	170	119	3000 K	DALI	1550 lm/13 W	652015-01-W-DD
2 x 18 W	R23	240	170	131	4000 K	DALI	1700 lm/13 W	652015-01-N-DD
1 x 42 W	R23	240	180	112	3000 K	DALI	2140 lm/19 W	652015-02-W-DD
1 x 42 W	R23	240	180	122	4000 K	DALI	2324 lm/19 W	652015-02-N-DD
2 x 26 W	R23	240	190	106	3000 K	DALI	2855 lm/27 W	652015-03-W-DD
2 x 26 W	R23	240	190	115	4000 K	DALI	3100 lm/27 W	652015-03-N-DD
2 x 32 W	R23	240	200	92	3000 K	DALI	3870 lm/42 W	652015-04-W-DD
2 x 32 W	R23	240	200	101	4000 K	DALI	4260 lm/42 W	652015-04-N-DD

HIT

2 x 18 W	R23	240	200	106	3000 K	DALI	5190 lm/49 W	656015-01-W-DD*
2 x 18 W	R23	240	200	118	4000 K	DALI	5700 lm/49 W	656015-01-N-DD*
1 x 42 W	R23	240	200	107	3000 K	DALI	8560 lm/80 W	656015-02-W-DD*
1 x 42 W	R23	240	200	118	4000 K	DALI	9450 lm/80 W	656015-02-N-DD*

* UGR < 20

DOWNLIGHT

Streuscheibe | Diffusing screen



TC-TEL(I)

2 x 13 W	R23	240	100	92	3000 K	DALI	830 lm / 9 W	650115-01-W-DD
2 x 13 W	R23	240	100	101	4000 K	DALI	910 lm / 9 W	650115-01-N-DD
2 x 18 W	R23	240	100	90	3000 K	DALI	1085 lm/12 W	650115-02-W-DD
2 x 18 W	R23	240	100	99	4000 K	DALI	1190 lm/12 W	650115-02-N-DD
1 x 42 W	R23	240	100	80	3000 K	DALI	1510 lm/19 W	650115-03-W-DD
1 x 42 W	R23	240	100	87	4000 K	DALI	1660 lm/19 W	650115-03-N-DD
2 x 32 W	R23	240	100	77	3000 K	DALI	1995 lm/26 W	650115-04-W-DD
2 x 32 W	R23	240	100	84	4000 K	DALI	2190 lm/26 W	650115-04-N-DD

Variante | Version
TENTECSL

2700 K
6500 K TunableWhite

Nicht für Version mit Streuscheibe
Not for version with diffusing screen

Notlicht | Emergency 3h

Weitere Notlicht-Varianten auf Anfrage
Emergency lighting variants on request

CASAMBI Steuerung | Control

1-10V Treiber | Driver

KOMPLETTLEUCHE

LED Downlights von heute sind kompakter als ihre konventionellen Vorgänger. Dies kann gerade bei Sanierungen oder in denkmalgeschützten Gebäuden ein Problem sein. Genau hierfür bietet SCHMITZ-WILA modernste LED Downlights, die ohne Mehraufwand in die vorhandenen Deckenausschnitte passen.

COMPLETE LUMINAIRE

Today's LED downlights are more compact than their conventional predecessors. This can be a problem especially for renovations or listed buildings. For this SCHMITZ-WILA provides state-of-the-art LED downlights that fit without extra effort into the ceiling cut-outs.

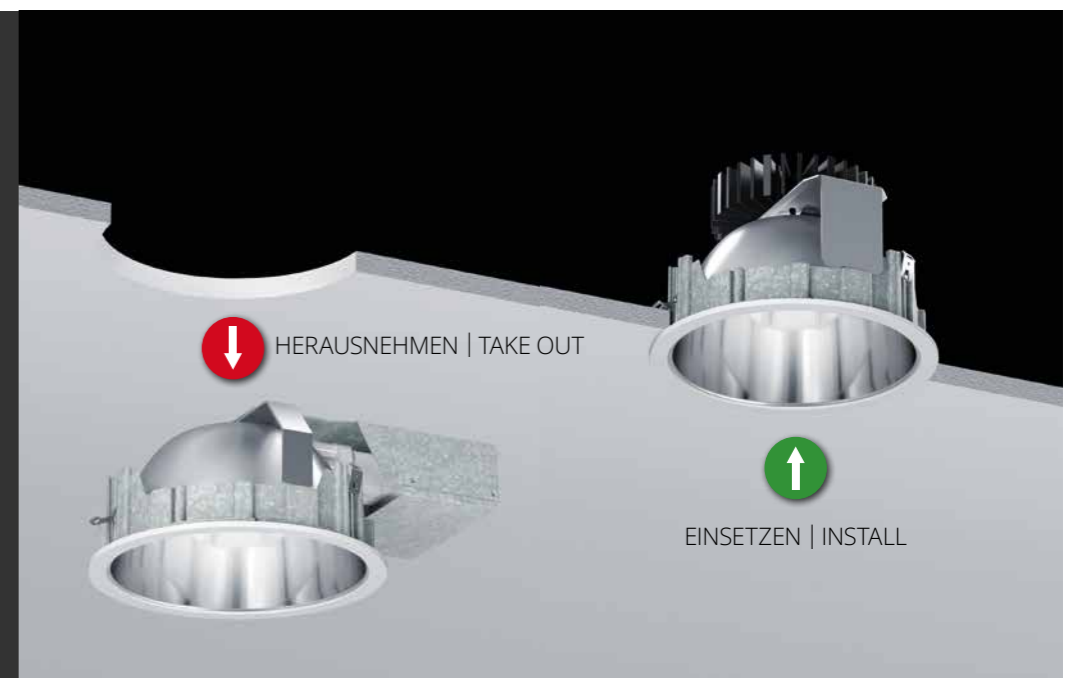

TENTEC SL Leuchteneinsatz | Luminaire insert

DOWNLIGHT ohne Schnellmontagering without quick mounting ring	ERSATZ REPLACEMENT	R	DA CO mm	ET RD mm	Effizienz lm/W	CCT	Treiber Driver	Leistung Wattage	Art.-Nr. Item No.
---	-----------------------	---	-------------	-------------	-------------------	-----	-------------------	---------------------	-------------------

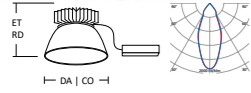

TC-TEL(I)									
2 x 18 W	R27	280	160	111	3000 K	DALI	1450 lm/13 W	663015-01-W-DD	
2 x 18 W	R27	280	160	122	4000 K	DALI	1590 lm/13 W	663015-01-N-DD	
1 x 42 W	R27	280	160	105	3000 K	DALI	2000 lm/19 W	663015-02-W-DD	
1 x 42 W	R27	280	160	115	4000 K	DALI	2195 lm/19 W	663015-02-N-DD	
2 x 26 W	R27	280	180	99	3000 K	DALI	2670 lm/27 W	663015-03-W-DD	
2 x 26 W	R27	280	180	108	4000 K	DALI	2930 lm/27 W	663015-03-N-DD	
2 x 32 W	R27	280	190	87	3000 K	DALI	3650 lm/42 W	663015-04-W-DD	
2 x 32 W	R27	280	190	96	4000 K	DALI	4010 lm/42 W	663015-04-N-DD	

DOWNLIGHT ohne Haltering/Streuscheibe without support ring/diffusing screen	Art.-Nr. Item No.
---	-------------------



TC-TEL(I)									
2 x 13 W	R27	280	100	105	3000 K	DALI	950 lm / 9 W	664115-01-W-DD	
2 x 13 W	R27	280	100	115	4000 K	DALI	1040 lm / 9 W	664115-01-N-DD	
2 x 18 W	R27	280	100	103	3000 K	DALI	1240 lm/12 W	664115-02-W-DD	
2 x 18 W	R27	280	100	113	4000 K	DALI	1360 lm/12 W	664115-02-N-DD	
1 x 42 W	R27	280	100	90	3000 K	DALI	1715 lm/19 W	664115-03-W-DD	
1 x 42 W	R27	280	100	99	4000 K	DALI	1880 lm/19 W	664115-03-N-DD	
2 x 32 W	R27	280	100	88	3000 K	DALI	2275 lm/26 W	664115-04-W-DD	
2 x 32 W	R27	280	100	96	4000 K	DALI	2500 lm/26 W	664115-04-N-DD	

LEUCHTENEINSATZ

Der vorhandene Montage- und Abdeckring wird erneut verwendet und nur der Leuchteneinsatz wird auf LED umgestellt. Höchster Sehkomfort, effiziente Grundbeleuchtung und maximale Wirtschaftlichkeit: kein zusätzlicher Zeitaufwand für neue Lösungen.

LUMINAIRE INSERT

The existing mounting and cover ring is used again. Only the luminaire insert is switched to LED. Maximum visual comfort, efficient ambient lighting and maximum economy: no additional time required for new solutions.

NEU | NEW

Es wird nur der Leuchteneinsatz geliefert! Vorhandener Montagering, Abschluss- oder Haltering mit Lichtoptik werden wiederverwendet.

Only the luminaire insert will be delivered! Existing mounting ring, cover or supporting ring with light optic are reused.



280 mm R27
240 mm R23
195 mm R18
165 mm R15

DECKENAUSSCHNITT | CEILING CUT-OUT
DA | CO



ACCESSORIES

KASCHIERRING

SCHMITZ-WILA verfügt über ein umfangreiches Produktportfolio an LED-Downlights für unterschiedlichste Anforderungen im Projekt. Wenn Sie die gesamte aktuelle Typenvielfalt nutzen wollen, ist der Kaschiererring die ideale Lösung.

CONCEAL RING

SCHMITZ-WILA provides an extensive product portfolio of LED downlights for a wide range of requirements in projects. The conceal ring is the ideal solution if you want to use the entire current variety of SCHMITZ-WILA luminaires.

LED Leuchtengröße Luminaire size	R23, DA CO 240 mm D 260 mm	R27, DA CO 280 mm D 300 mm
R15 DA CO 165 mm	612418R15	612518R15
R18 DA CO 195 mm	612418R18	612518R18
R23 DA CO 240 mm	-	612518R23

Variante | Version
TENTEC SL

RAL nach Wahl|of choice

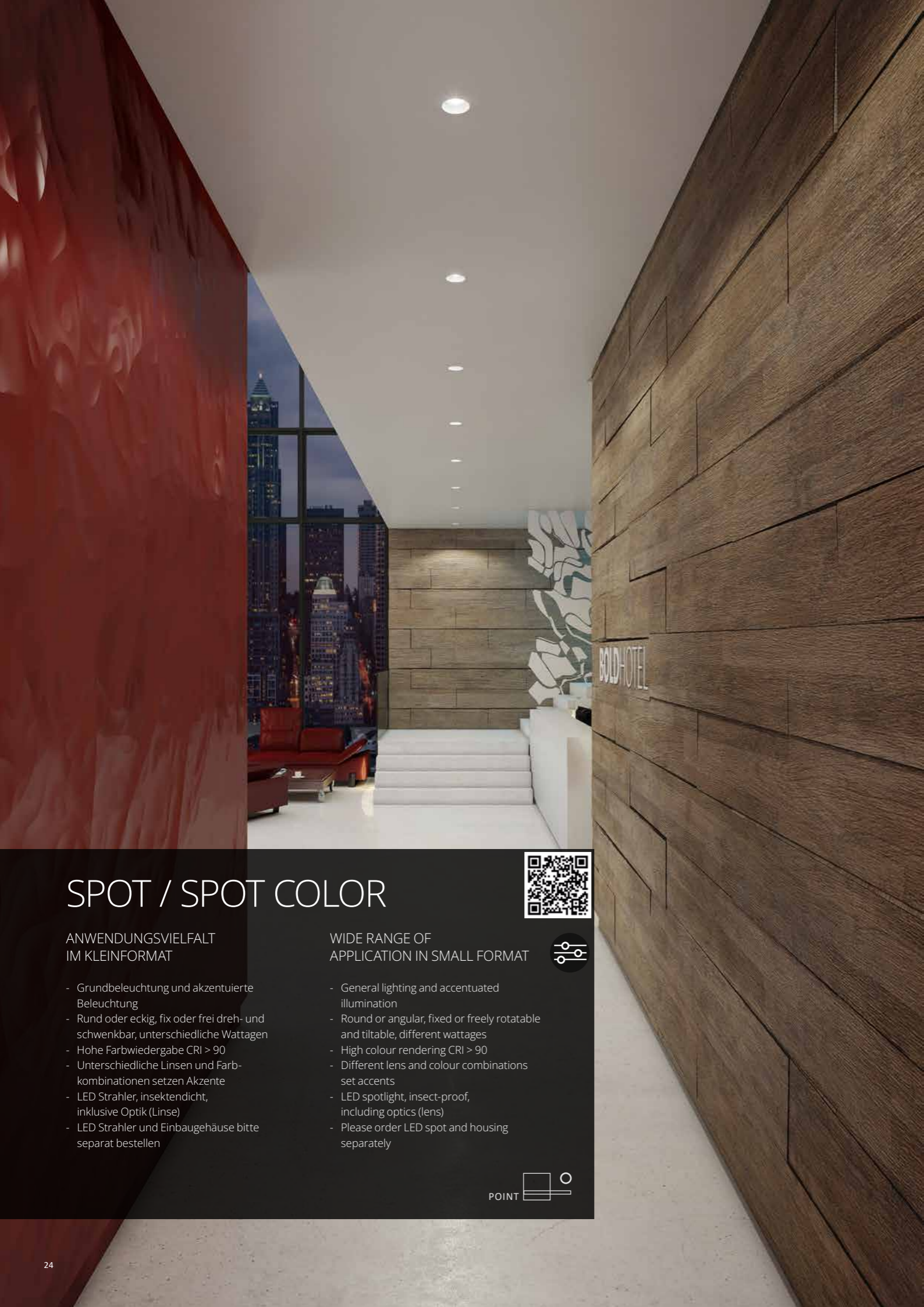

SPOT / SPOT COLOR

ANWENDUNGSVIELFALT
IM KLEINFORMAT

- Grundbeleuchtung und akzentuierte Beleuchtung
- Rund oder eckig, fix oder frei dreh- und schwenkbar, unterschiedliche Wattagen
- Hohe Farbwiedergabe CRI > 90
- Unterschiedliche Linsen und Farbkombinationen setzen Akzente
- LED Strahler, insektendicht, inklusive Optik (Linse)
- LED Strahler und Einbaugehäuse bitte separat bestellen

WIDE RANGE OF
APPLICATION IN SMALL FORMAT

- General lighting and accentuated illumination
- Round or angular, fixed or freely rotatable and tiltable, different wattages
- High colour rendering CRI > 90
- Different lens and colour combinations set accents
- LED spotlight, insect-proof, including optics (lens)
- Please order LED spot and housing separately



SPOT / SPOT COLOR Downlights

RICHTSTRAHLER SPOTLIGHT	Ausstrahlung Beam angle	CCT	Treiber Driver	Leistung Wattage	Art.-Nr. Item No.
 + 139-007-100	SPOT 15°	3000 K	ON/OFF	610 lm / 8 W	143-021-103
	SPOT 15°	4000 K	ON/OFF	660 lm / 8 W	143-021-104
	SPOT 15°	3000 K	DALI	610 lm / 8 W	143-021-123
	SPOT 15°	4000 K	DALI	660 lm / 8 W	143-021-124
	SPOT 15°	3000 K	ON/OFF	1410 lm/13 W	143-022-103
	SPOT 15°	4000 K	ON/OFF	1510 lm/13 W	143-022-104
	SPOT 15°	3000 K	DALI	1410 lm/13 W	143-022-123
	SPOT 15°	4000 K	DALI	1510 lm/13 W	143-022-124
	MEDIUM 30°	3000 K	ON/OFF	610 lm / 8 W	143-031-103
	MEDIUM 30°	4000 K	ON/OFF	660 lm / 8 W	143-031-104
	MEDIUM 30°	3000 K	DALI	610 lm / 8 W	143-031-123
	MEDIUM 30°	4000 K	DALI	660 lm / 8 W	143-031-124
	MEDIUM 30°	3000 K	ON/OFF	1410 lm/13 W	143-032-103
	MEDIUM 30°	4000 K	ON/OFF	1510 lm/13 W	143-032-104
	MEDIUM 30°	3000 K	DALI	1410 lm/13 W	143-032-123
	MEDIUM 30°	4000 K	DALI	1510 lm/13 W	143-032-124
	FLOOD 50°	3000 K	ON/OFF	600 lm / 8 W	143-041-103
	FLOOD 50°	4000 K	ON/OFF	650 lm / 8 W	143-041-104
	FLOOD 50°	3000 K	DALI	600 lm / 8 W	143-041-123
	FLOOD 50°	4000 K	DALI	650 lm / 8 W	143-041-124
	FLOOD 50°	3000 K	ON/OFF	1390 lm/13 W	143-042-103
	FLOOD 50°	4000 K	ON/OFF	1480 lm/13 W	143-042-104
	FLOOD 50°	3000 K	DALI	1390 lm/13 W	143-042-123
	FLOOD 50°	4000 K	DALI	1480 lm/13 W	143-042-124

CCT 2700 K / Phase dim auf Anfrage | on request

STELLEN SIE SICH IHREN SPOT ZUSAMMEN, AUS STRAHLER UND LEUCHTENGEHÄUSE.

Als Grundbeleuchtung für Decken in Fluren, Büro- und Privaträumen ebenso wie für die akzentuierte Beleuchtung einzelner Gegenstände oder Flächen.

ASSEMBLE YOUR SPOT FROM THE SPOTLIGHT AND LUMINAIRE HOUSING.

SPOT serves as general lighting in corridors, office interiors and private rooms as well as for highlighting selected objects or areas.



STRAHLER
wahlweise 8 oder 13 W

SPOTLIGHT
optionally 8 or 13 W



+
ZUBEHÖR
ACCESSORIES
optional















+
LEUCHTENGEHÄUSE
LUMINAIRE HOUSING





SPOT Downlights

EINBAUGEHÄUSE HOUSING	D mm	DA CO mm	ET RD mm	ART-NR. ITEM NO.	○	●
 $\leq 12,5$ mm	○ 65	○ 58	70	139-003-100	137-003-200	
 $\leq 12,5$ mm	○ 65	○ 58	70	139-004-100	-	
 ≤ 20	○ 78	○ 67	70	139-005-100	137-005-200	
 ≤ 30	○ 82	○ 77	105	139-006-100	-	
 ≤ 30	○ 88	○ 75	95	139-007-100	-	
 ≤ 30	○ 90 (8 W)	○ 82	90	139-008-100	-	
 ≤ 30	○ 110 (15 W)	○ 82	90	139-008-100	-	
 ≤ 20	○ 74	○ 83	90	139-011-100	-	
L x B W mm						
 ≤ 25	□ 90	□ 82	70	139-009-100	-	
 ≤ 20	□ 108	□ 96	70	139-010-100	-	
 ≤ 20	□ 92	□ 94	70	139-012-100	-	
 ≤ 20	○ 93	○ 65	81	139-013-100	-	

IP65

KLASSISCHE INTEGRATION



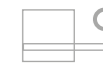

Dieses ausgesprochen vielfältige Leuchtensystem passt perfekt zu den visuellen Anforderungen, die an moderne Büro-, Privat- oder Hotelräume gestellt werden. Leuchtgehäuse und Strahler, bitte separat bestellen

TRADITIONAL INTEGRATION

Yet this lighting system is highly diversified in terms of model variants and application options. This extremely versatile luminaire system perfectly meets the visual demands made on today's office, residential or hotel spaces. Please order LED spot and housing separately



SPOT COLOR Downlights

EINBAUGEHÄUSE HOUSING	D mm	DA CO mm	ET RD mm	ART-NR. ITEM NO.	○ Refl.	● Refl.	● Refl.
 ≤ 30	○ 81	○ 68	80	143-113-110	143-113-130	143-113-140	
 ≤ 30	○ 95	○ 80	80	143-114-110	143-114-130	143-114-140	
 ≤ 20	○ 60	○ 65	80	143-116-110	143-116-130	143-116-140	
L x B W mm							
 ≤ 25	□ 80	□ 65	80	143-115-110	143-115-130	143-115-140	
 ≤ 20	□ 62	□ 65	80	143-117-110	143-117-130	143-117-140	

GESTALTERISCHE AKZENTE

Die Farbeinsätze in Weiß, Schwarz oder Gold ermöglichen sowohl die unauffällige Deckenintegration als auch die technische oder dekorative Hervorhebung.

DESIGN STATEMENT

Colour inserts in white, black or gold either ensure unobtrusive ceiling integration or highlight the technical and decorative features.

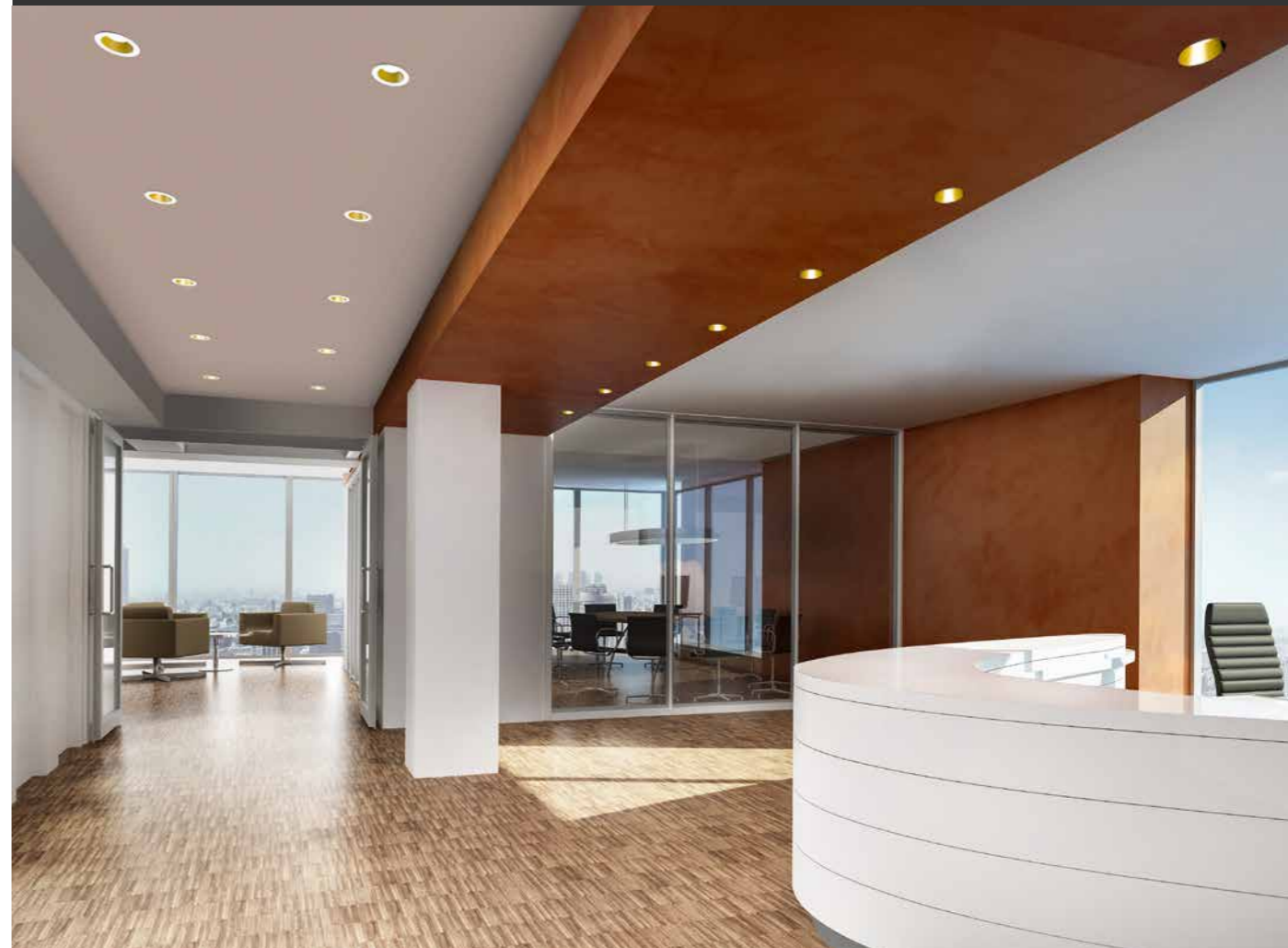

I
n
d
e
x



SIRO

HÖCHSTE LICHTQUALITÄT IN MINIMALISTISCHEM DESIGN

- D 80/120 mm mit innenliegendem Spiegelreflektor
- D 160 mm Spiegelreflektor mit integrierter Diffusorkalotte für homogene Lichtverteilung UGR < 19, 65° < 1000 cd/m²
- 1 x 2 SDCM sorgen für ein perfektes Beleuchtungsergebnis
- Hohe Farbwiedergabe CRI > 90
- Integriertes Betriebsgerät
- Direkt- und Indirektanteil getrennt steuerbar per DALI-Adressierung

HIGHEST QUALITY OF LIGHT PLUS MINIMALIST DESIGN

- D 80/120 mm with inlying mirror reflector
- D 160 mm mirror reflector with integrated diffuser cap UGR < 19, 65° < 1000 cd/m²
- 1 x 2 SDCM ensure a perfect lighting result
- High colour rendering CRI > 90
- Built-in control gear
- Separately controllable direct and indirect component via DALI addressing



Klosterkirche Attel, Landkreis Rosenheim | Schmidt König Lichtplaner, München | Foto Michael Heinrich, München

SIRO Anbau- und Pendelleuchten | Surface and Pendant luminaires

ANBAU SURFACE		D mm	H mm	CCT	Treiber Driver	Leistung Wattage	Art.-Nr. Item No.	CRI > 90	3000K	4000K	DALI	IP40
		120	290	3000 K	DALI	1460 lm/13 W	SR1461333-33-30-DD	●				
		120	290	4000 K	DALI	1460 lm/13 W	SR1461333-33-40-DD		●			
		160	280	3000 K	DALI	2360 lm/19 W	SR1461091-33-30-DD					
		160	280	4000 K	DALI	2430 lm/19 W	SR1461091-33-40-DD					
		160	280	3000 K	DALI	4340 lm/41 W	SR1461093-33-30-DD					
		160	280	4000 K	DALI	4460 lm/41 W	SR1461093-33-40-DD					
PENDEL PENDANT*												
		80	330	3000 K	DALI	2330 lm/19 W	SR1561358-33-32-DD					
		80	330	4000 K	DALI	2400 lm/19 W	SR1561358-33-42-DD					
		80	390	3000 K	DALI	1820 lm/15 W	SR1567315-33-32-DD					
		80	390	4000 K	DALI	1820 lm/15 W	SR1567315-33-42-DD					
		120	330	3000 K	DALI	1460 lm/13 W	SR1561333-33-32-DD					
		120	330	4000 K	DALI	1460 lm/13 W	SR1561333-33-42-DD					
		120	390	3000 K	DALI	2310 lm/21 W	SR1567333-33-32-DD					
		120	390	4000 K	DALI	2310 lm/21 W	SR1567333-33-42-DD					
		160	255	3000 K	DALI	2360 lm/19 W	SR1561091-33-32-DD					
		160	255	4000 K	DALI	2430 lm/19 W	SR1561091-33-42-DD					
		160	255	3000 K	DALI	4340 lm/41 W	SR1561093-33-32-DD					
		160	255	4000 K	DALI	4460 lm/41 W	SR1561093-33-42-DD					
		160	370	3000 K	DALI	5280 lm/53 W	SR1567093-33-32-DD					
		160	370	4000 K	DALI	5430 lm/53 W	SR1567093-33-42-DD					

* Pendellänge | Pendant length 1500 mm

Variante | Version
SIRO

RAL nach Wahl | of choice

MODERNES BELEUCHTUNGSKONZEPT Denkmalgeschützte Gebäude stellen eine ganz besondere Herausforderung dar. Das Licht sollte festlich, mit ausgewogener Schattigkeit und gleichzeitig nicht zu dramatisch sein, durch den breiten Ausstrahlungswinkel gibt es eine gute Überlagerung der Lichtkegel zur gleichmäßigen Anstrahlung des Gewölbes und zur Beleuchtung des Gestühls im Hauptschiff.

MODERN LIGHTING CONCEPT Heritage buildings represent a special challenge. It was supposed to be festive with an equilibrated direction of light and modelling, while at the same time not to be too dramatic. The wide angle of refraction creates an overlap of the light beam, allowing for an even illumination of the vault and seating area in the main aisle.



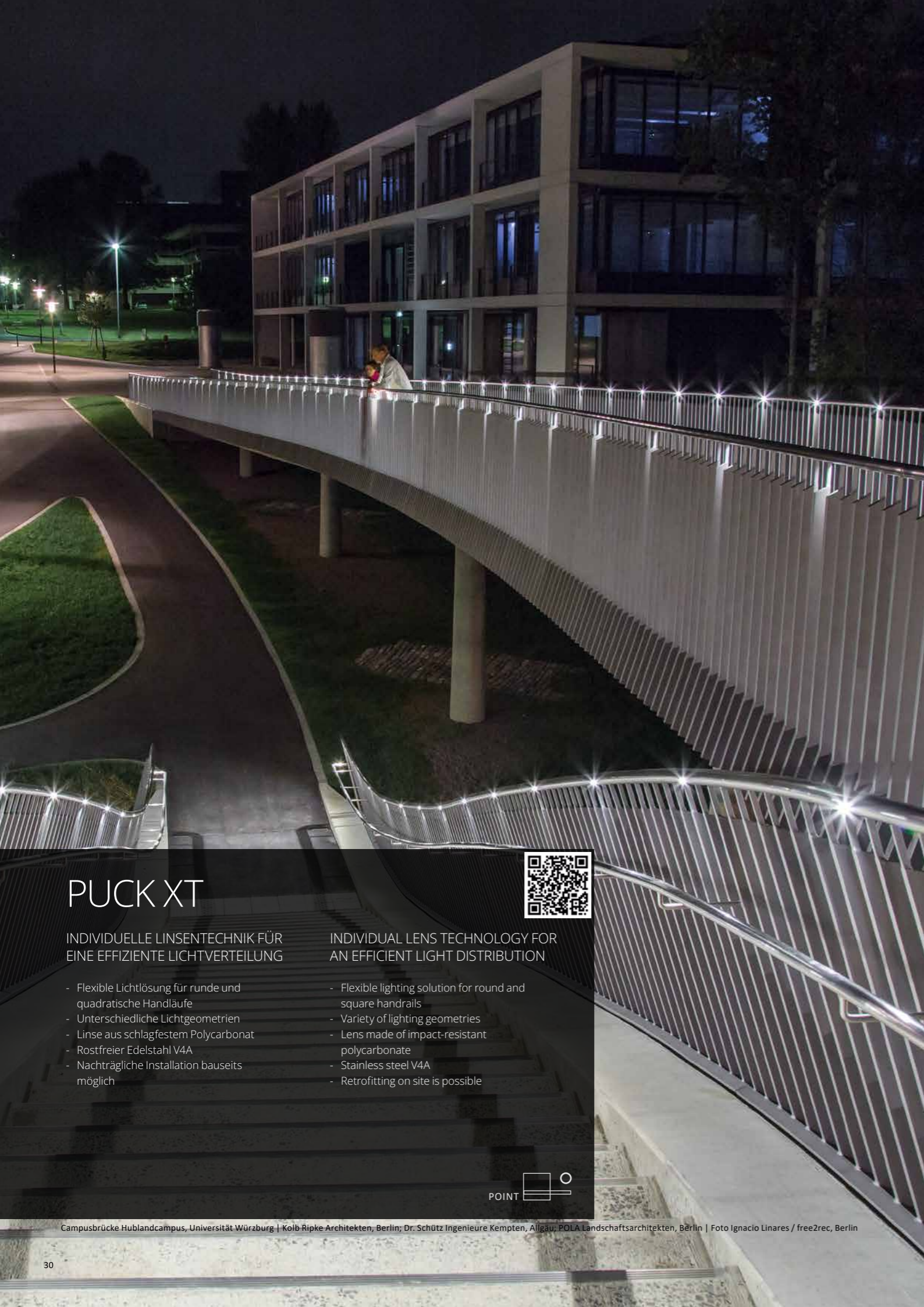

PUCK XT

INDIVIDUELLE LINSENTECHNIK FÜR EINE EFFIZIENTE LICHTVERTEILUNG

- Flexible Lichtlösung für runde und quadratische Handläufe
- Unterschiedliche Lichtgeometrien
- Linse aus schlagfestem Polycarbonat
- Rostfreier Edelstahl V4A
- Nachträgliche Installation bauseits möglich

INDIVIDUAL LENS TECHNOLOGY FOR AN EFFICIENT LIGHT DISTRIBUTION

- Flexible lighting solution for round and square handrails
- Variety of lighting geometries
- Lens made of impact-resistant polycarbonate
- Stainless steel V4A
- Retrofitting on site is possible

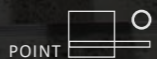

PUCK XT Leuchten für Handläufe | Luminaires for handrails

EINBAUSTRAHLER RECESSED SPOT	Ausstrahlung Beam angle	D mm	H mm	ET RD mm	CCT	Treiber Driver	Leistung Wattage	CRI >80	3000 K	4000 K	DALI	ON OFF	IK10	IP66	Art.-Nr. Item No.
	einseitig one-sided 60°	18	15	18	3000 K 4000 K	ON/OFF	170 lm/1,5 W								MP1201501-70-30
						ON/OFF	180 lm/1,5 W						MP1201501-70-40		
	zweiseitig two-sided 90°	18	15	18	3000 K 4000 K	ON/OFF	175 lm/1,5 W								MP1201503-70-30
						ON/OFF	185 lm/1,5 W						MP1201503-70-40		
	asymmetrisch asymmetrical 20°/60°	18	15	18	3000 K 4000 K	ON/OFF	160 lm/1,5 W								MP1201505-70-30
						ON/OFF	170 lm/1,5 W						MP1201505-70-40		
	asymmetrisch asymmetrical 20°/60°	18	15	18	3000 K 4000 K	ON/OFF	160 lm/1,5 W								MP1201511-70-30
						ON/OFF	170 lm/1,5 W						MP1201511-70-40		
	zweiseitig two-sided 90°	18	15	18	3000 K 4000 K	ON/OFF	175 lm/1,5 W								MP1201513-70-30
						ON/OFF	185 lm/1,5 W						MP1201513-70-40		

i PUCK XT besteht aus Einbaustrahler, Betriebsgerät, Einschraubwerkzeug und Gel-Verbinder, bitte separat bestellen.
PUCK XT consists of a recessed spot, LED unit, insertion tool and gel connector, please order separately.

ZUBEHÖR | ACCESSORIES

ART.-NR. | ITEM NO.

NOTWENDIG | NECESSARY

LED-Betriebsgerät | LED UNIT
Betrieb von max. 20 PUCKs pro
Betriebseinheit (SELV) | operation
of max. 20 PUCKs per unit (SELV)

LED PUCK Treiber Driver max. 35 W 500 mA	ON/OFF	83746
LED PUCK Treiber Driver max. 35 W 500 mA	DALI	83747



Einschraubwerkzeug Insertion tool COMFORT	MP-011
Einschraubwerkzeug Insertion tool ECO	MP-015
Gel-Verbinder Gel connector 2 x per PUCK	MP-003

OPTIONAL

Verpresswerkzeug Tool for tight crimping	MP-002
Schrauben-Befestigungslack Thread locking fluid	MP-004

MEHR SICHERHEIT

Bündig in die Unterseite des Handlaufs integrierte LED PUCKs sind tagsüber fast unsichtbar. Abends sorgt das Licht der kleinen LED-Spots (1,5 W) für eine normgerechte Ausleuchtung des behindertengerecht gestalteten Aufgangs.

MORE SAFETY

Built in flush with the lower edge of the handrail LED PUCKs are nearly invisible during the day. In the evening the light emitted by the little LED spots of just 1.5 W illuminates the barrier-free access in compliance with the relevant standards.





CLEAR 4.0

PROGRAMMVIelfALT VON AKZENT-
BIS BÜROBELEUCHTUNG

- Abgesetzter Leuchtenkörper
- Kleiner Indirektanteil zur Decken-/
Wandaufhellung
- Zwei Abdeckungen zur Wahl
Acryl satiniert (PUBLIC) oder
Acryl Prismatic (OFFICE)

PROGRAM VARIETY FROM ACCENT
TO OFFICE LIGHTING

- Detached housing
- Small indirect component for a soft
ceiling illumination
- Two covers to choose from
Acryl satin-coated (PUBLIC) or
Acryl prismatic (OFFICE)









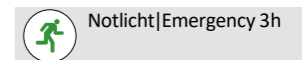
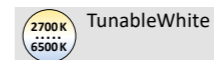
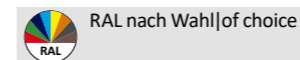

CLEAR 4.0 Anbauleuchten | Surface luminaires

PUBLIC ACRYL satiniert satin-finished	D mm	H mm	CCT	Treiber Driver	Leistung Wattage	Art.-Nr. Item No.						
	o 340	90	3000 K	ON/OFF	1650 lm/13 W	156-1430-10-30						
	o 340	90	4000 K	ON/OFF	1750 lm/13 W	156-1430-10-40						
	o 340	90	3000 K	DALI	1650 lm/13 W	156-1430-12-30						
	o 340	90	4000 K	DALI	1750 lm/13 W	156-1430-12-40						
	o 450	90	3000 K	ON/OFF	2750 lm/20 W	156-1440-10-30						
	o 450	90	4000 K	ON/OFF	2900 lm/20 W	156-1440-10-40						
	o 450	90	3000 K	DALI	2750 lm/20 W	156-1440-12-30						
	o 450	90	4000 K	DALI	2900 lm/20 W	156-1440-12-40						
	o 625	90	3000 K	ON/OFF	6300 lm/42 W	156-1460-10-30						
	o 625	90	4000 K	ON/OFF	6650 lm/42 W	156-1460-10-40						
	o 625	90	3000 K	DALI	6300 lm/42 W	156-1460-12-30						
	o 625	90	4000 K	DALI	6650 lm/42 W	156-1460-12-40						
	o 850	90	3000 K	ON/OFF	11850 lm/84 W	156-1480-10-30						
	o 850	90	4000 K	ON/OFF	12500 lm/84 W	156-1480-10-40						
	o 850	90	3000 K	DALI	11850 lm/84 W	156-1480-12-30						
	o 850	90	4000 K	DALI	12500 lm/84 W	156-1480-12-40						
L x B W mm												
	□ 300	90	3000 K	ON/OFF	1600 lm/14 W	156-2430-10-30						
	□ 300	90	4000 K	ON/OFF	1650 lm/14 W	156-2430-10-40						
	□ 300	90	3000 K	DALI	1600 lm/14 W	156-2430-12-30						
	□ 300	90	4000 K	DALI	1650 lm/14 W	156-2430-12-40						
	□ 435	90	3000 K	ON/OFF	3200 lm/25 W	156-2440-10-30						
	□ 435	90	4000 K	ON/OFF	3350 lm/25 W	156-2440-10-40						
	□ 435	90	3000 K	DALI	3200 lm/25 W	156-2440-12-30						
	□ 435	90	4000 K	DALI	3350 lm/25 W	156-2440-12-40						
	□ 580	90	3000 K	ON/OFF	6250 lm/47 W	156-2460-10-30						
	□ 580	90	4000 K	ON/OFF	6600 lm/47 W	156-2460-10-40						
	□ 580	90	3000 K	DALI	6250 lm/47 W	156-2460-12-30						
	□ 580	90	4000 K	DALI	6600 lm/47 W	156-2460-12-40						
	□ 850	90	3000 K	ON/OFF	14050 lm/107 W	156-2480-10-30						
	□ 850	90	4000 K	ON/OFF	14750 lm/107 W	156-2480-10-40						
	□ 850	90	3000 K	DALI	14050 lm/107 W	156-2480-12-30						
	□ 850	90	4000 K	DALI	14750 lm/107 W	156-2480-12-40						
	310 x 580	90	3000 K	ON/OFF	3150 lm/25 W	156-3460-10-30						
	310 x 580	90	4000 K	ON/OFF	3300 lm/25 W	156-3460-10-40						
	310 x 580	90	3000 K	DALI	3150 lm/25 W	156-3460-12-30						
	310 x 580	90	4000 K	DALI	3300 lm/25 W	156-3460-12-40						
	310 x 840	90	3000 K	ON/OFF	4700 lm/36 W	156-3480-10-30						
	310 x 840	90	4000 K	ON/OFF	4950 lm/36 W	156-3480-10-40						
	310 x 840	90	3000 K	DALI	4700 lm/36 W	156-3480-12-30						
	310 x 840	90	4000 K	DALI	4950 lm/36 W	156-3480-12-40						
	310 x 1120	90	3000 K	ON/OFF	6250 lm/47 W	156-3411-10-30						
	310 x 1120	90	4000 K	ON/OFF	6600 lm/47 W	156-3411-10-40						
	310 x 1120	90	3000 K	DALI	6250 lm/47 W	156-3411-12-30						
	310 x 1120	90	4000 K	DALI	6600 lm/47 W	156-3411-12-40						

Variante | Version
CLEAR 4.0



Weitere Notlicht-Varianten auf Anfrage
Emergency lighting variants on request

OFFICE ACRYL Prismatic prismatic	D mm	H mm	CCT	Treiber Driver	Leistung Wattage	Art.-Nr. Item No.	UGR <19	CR >80	3000K	4000K	DALI	ON OFF	IP40	
	o 340	90	3000 K	ON/OFF	1600 lm/13 W	156-1530-10-30	●	●	●	●	●	●	●	
	o 340	90	4000 K	ON/OFF	1650 lm/13 W	156-1530-10-40	●	●	●	●	●	●	●	
	o 340	90	3000 K	DALI	1600 lm/13 W	156-1530-12-30	●	●	●	●	●	●	●	
	o 340	90	4000 K	DALI	1650 lm/13 W	156-1530-12-40	●	●	●	●	●	●	●	
	o 450	90	3000 K	ON/OFF	2600 lm/20 W	156-1540-10-30	●	●	●	●	●	●	●	
	o 450	90	4000 K	ON/OFF	2700 lm/20 W	156-1540-10-40	●	●	●	●	●	●	●	
	o 450	90	3000 K	DALI	2600 lm/20 W	156-1540-12-30	●	●	●	●	●	●	●	
	o 450	90	4000 K	DALI	2700 lm/20 W	156-1540-12-40	●	●	●	●	●	●	●	
	o 625	90	3000 K	ON/OFF	5950 lm/42 W	156-1560-10-30	●	●	●	●	●	●	●	
	o 625	90	4000 K	ON/OFF	6300 lm/42 W	156-1560-10-40	●	●	●	●	●	●	●	
	o 625	90	3000 K	DALI	5950 lm/42 W	156-1560-12-30	●	●	●	●	●	●	●	
	o 625	90	4000 K	DALI	6300 lm/42 W	156-1560-12-40	●	●	●	●	●	●	●	
	□ 300	90	3000 K	ON/OFF	1500 lm/14 W	156-2530-10-30	●	●	●	●	●	●	●	
	□ 300	90	4000 K	ON/OFF	1550 lm/14 W	156-2530-10-40	●	●	●	●	●	●	●	
	□ 300	90	3000 K	DALI	1500 lm/14 W	156-2530-12-30	●	●	●	●	●	●	●	
	□ 300	90	4000 K	DALI	1550 lm/14 W	156-2530-12-40	●	●	●	●	●	●	●	
		□ 435	90	3000 K	ON/OFF	3050 lm/25 W	156-2540-10-30	●	●	●	●	●	●	●
		□ 435	90	4000 K	ON/OFF	3200 lm/25 W	156-2540-10-40	●	●	●	●	●	●	●
		□ 435	90	3000 K	DALI	3050 lm/25 W	156-2540-12-30	●	●	●	●	●	●	●
		□ 435	90	4000 K	DALI	3200 lm/25 W	156-2540-12-40	●	●	●	●	●	●	●
		□ 580	90	3000 K	ON/OFF	5900 lm/47 W	156-2560-10-30	●	●	●	●	●	●	●
		□ 580	90	4000 K	ON/OFF	6200 lm/47 W	156-2560-10-40	●	●	●	●	●	●	●
		□ 580	90	3000 K	DALI	5900 lm/47 W	156-2560-12-30	●	●	●	●	●	●	●
		□ 580	90	4000 K	DALI	6200 lm/47 W	156-2560-12-40	●	●	●	●	●	●	●
	310 x 580	90	3000 K	ON/OFF	2950 lm/25 W	156-3560-10-30	●	●	●	●	●	●	●	
	310 x 580	90	4000 K	ON/OFF	3100 lm/25 W	156-3560-10-40	●	●	●	●	●	●	●	
	310 x 580	90	3000 K	DALI	2950 lm/25 W	156-3560-12-30	●	●	●	●	●	●	●	
	310 x 580	90	4000 K	DALI	3100 lm/25 W	156-3560-12-40	●	●	●	●	●	●	●	
	310 x 840	90	3000 K	ON/OFF	4450 lm/36 W	156-3580-10-30	●	●	●	●	●	●	●	
	310 x 840	90	4000 K	ON/OFF	4650 lm/36 W	156-3580-10-40	●	●	●	●	●	●	●	
	310 x 840	90	3000 K	DALI	4450 lm/36 W	156-3580-12-30	●	●	●	●	●	●	●	
	310 x 840	90	4000 K	DALI	4650 lm/36 W	156-3580-12-40	●	●	●	●	●	●	●	
	310 x 1120	90	3000 K	ON/OFF	5900 lm/47 W	156-3511-10-30	●	●	●	●	●	●	●	
	310 x 1120	90	4000 K	ON/OFF	6200 lm/47 W	156-3511-10-40	●	●	●	●	●	●	●	
	310 x 1120	90	3000 K	DALI	5900 lm/47 W	156-3511-12-30	●	●	●	●	●	●	●	
	310 x 1120	90	4000 K	DALI	6200 lm/47 W	156-3511-12-40	●	●	●	●	●	●	●	

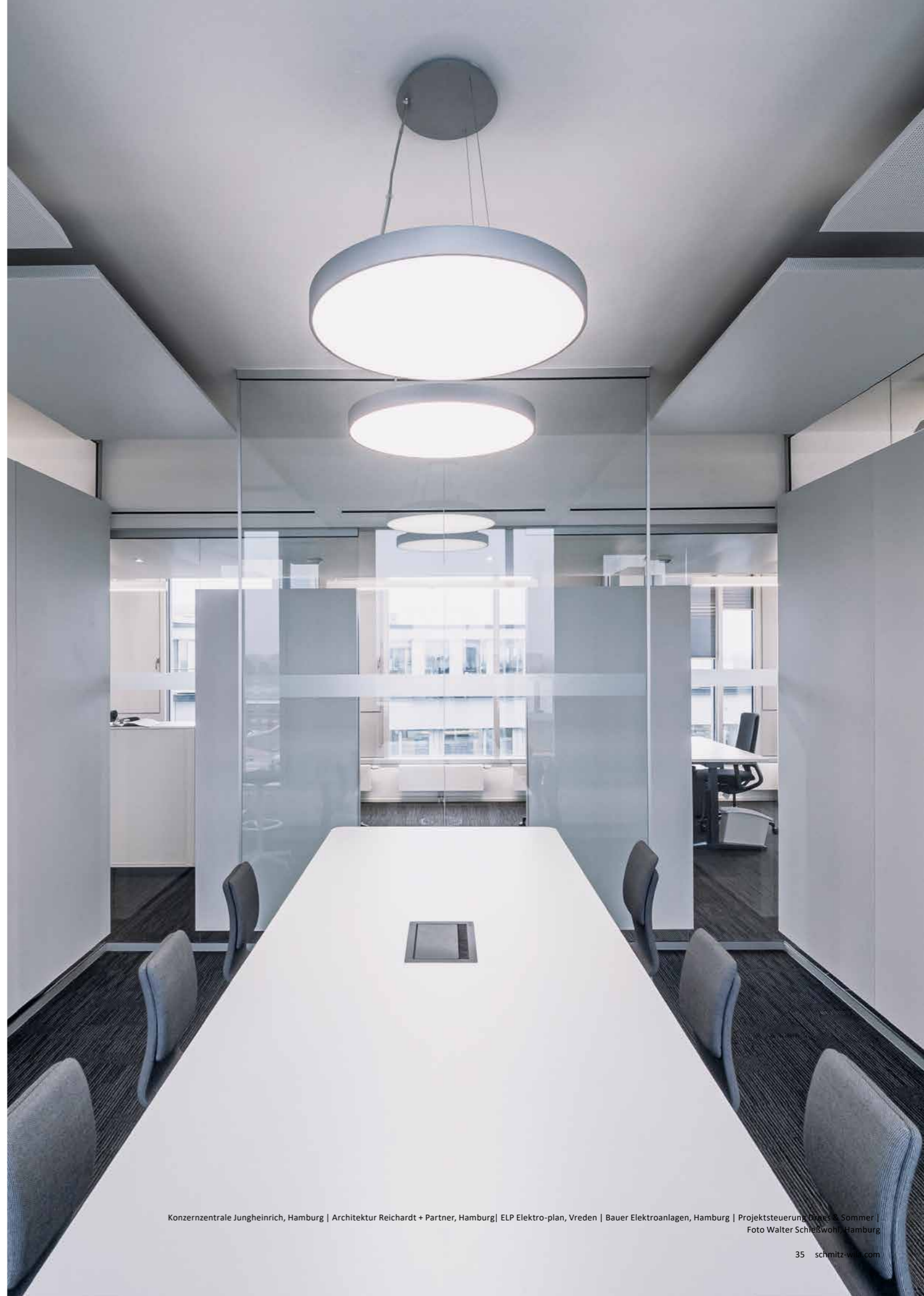



CLEAR FLAT

FLACHES, SCHWEBENDES
ERSCHEINUNGSBILD

- Abgesetzter Leuchtenkörper
- Dekorativer Indirektanteil zur Decken-/Wandaufhellung
- Zwei Abdeckungen zur Wahl Acryl satiniert (PUBLIC) oder Acryl Prismatic (OFFICE)

FLAT, FLOATING APPEARANCE

- Detached housing
- Decorative indirect component for a soft ceiling illumination
- Two covers to choose from Acryl satin-coated (PUBLIC) or Acryl prismatic (OFFICE)



CLEAR FLAT Anbauleuchten | Surface luminaires

PUBLIC	ACRYL satiniert satin-finished	D mm	H mm	CCT	Treiber Driver	Leistung Wattage	Art.-Nr. Item No.	<input checked="" type="checkbox"/> CRI >80	<input checked="" type="checkbox"/> 3000 K	<input checked="" type="checkbox"/> 4000 K	<input checked="" type="checkbox"/> DALI	<input checked="" type="checkbox"/> ON OFF	<input checked="" type="checkbox"/> IP40
--------	--------------------------------	------	------	-----	-----------------	-------------------	-------------------	---	--	--	--	--	--

	o 340	75	3000 K	ON/OFF	1600 lm/13 W	157-1430-10-30	157-1430-20-30	157-1430-30-30
	o 340	75	4000 K	ON/OFF	1700 lm/13 W	157-1430-10-40	157-1430-20-40	157-1430-30-40
	o 340	75	3000 K	DALI	1600 lm/13 W	157-1430-12-30	157-1430-22-30	157-1430-32-30
	o 340	75	4000 K	DALI	1700 lm/13 W	157-1430-12-40	157-1430-22-40	157-1430-32-40
	o 450	75	3000 K	ON/OFF	2650 lm/20 W	157-1440-10-30	157-1440-20-30	157-1440-30-30
	o 450	75	4000 K	ON/OFF	2800 lm/20 W	157-1440-10-40	157-1440-20-40	157-1440-30-40
	o 450	75	3000 K	DALI	2650 lm/20 W	157-1440-12-30	157-1440-22-30	157-1440-32-30
	o 450	75	4000 K	DALI	2800 lm/20 W	157-1440-12-40	157-1440-22-40	157-1440-32-40
	o 625	75	3000 K	ON/OFF	6100 lm/42 W	157-1460-10-30	157-1460-20-30	157-1460-30-30
	o 625	75	4000 K	ON/OFF	6450 lm/42 W	157-1460-10-40	157-1460-20-40	157-1460-30-40
	o 625	75	3000 K	DALI	6100 lm/42 W	157-1460-12-30	157-1460-22-30	157-1460-32-30
	o 625	75	4000 K	DALI	6450 lm/42 W	157-1460-12-40	157-1460-22-40	157-1460-32-40
	o 850	75	3000 K	ON/OFF	11500 lm/84 W	157-1480-10-30	157-1480-20-30	157-1480-30-30
	o 850	75	4000 K	ON/OFF	12100 lm/84 W	157-1480-10-40	157-1480-20-40	157-1480-30-40
	o 850	75	3000 K	DALI	11500 lm/84 W	157-1480-12-30	157-1480-22-30	157-1480-32-30
	o 850	75	4000 K	DALI	12100 lm/84 W	157-1480-12-40	157-1480-22-40	157-1480-32-40

L x B | W mm

	□ 300	75	3000 K	ON/OFF	1550 lm/14 W	157-2430-10-30	157-2430-20-30	157-2430-30-30
	□ 300	75	4000 K	ON/OFF	1600 lm/14 W	157-2430-10-40	157-2430-20-40	157-2430-30-40
	□ 300	75	3000 K	DALI	1550 lm/14 W	157-2430-12-30	157-2430-22-30	157-2430-32-30
	□ 300	75	4000 K	DALI	1600 lm/14 W	157-2430-12-40	157-1430-22-40	157-2430-32-40
	□ 435	75	3000 K	ON/OFF	3100 lm/25 W	157-2440-10-30	157-2440-20-30	157-2440-30-30
	□ 435	75	4000 K	ON/OFF	3250 lm/25 W	157-2440-10-40	157-2440-20-40	157-2440-30-40
	□ 435	75	3000 K	DALI	3100 lm/25 W	157-2440-12-30	157-2440-22-30	157-2440-32-30
	□ 435	75	4000 K	DALI	3250 lm/25 W	157-2440-12-40	157-2440-22-40	157-2440-32-40
	□ 580	75	3000 K	ON/OFF	6100 lm/47 W	157-2460-10-30	157-2460-20-30	157-2460-30-30
	□ 580	75	4000 K	ON/OFF	6400 lm/47 W	157-2460-10-40	157-2460-20-40	157-2460-30-40
	□ 580	75	3000 K	DALI	6100 lm/47 W	157-2460-12-30	157-2460-22-30	157-2460-32-30
	□ 580	75	4000 K	DALI	6400 lm/47 W	157-2460-12-40	157-2460-22-40	157-2460-32-40
	□ 850	75	3000 K	ON/OFF	13650 lm/107 W	157-2480-10-30	157-2480-20-30	157-2480-30-30
	□ 850	75	4000 K	ON/OFF	14350 lm/107 W	157-2480-10-40	157-2480-20-40	157-2480-30-40
	□ 850	75	3000 K	DALI	13650 lm/107 W	157-2480-12-30	157-2480-22-30	157-2480-32-30
	□ 850	75	4000 K	DALI	14350 lm/107 W	157-2480-12-40	157-2480-22-40	157-2480-32-40

Variante | Version
CLEAR FLAT

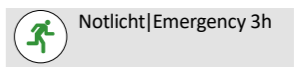
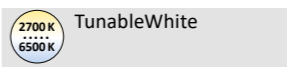
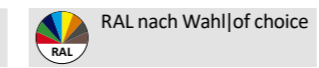

Weitere Notlicht-Varianten auf Anfrage
Emergency lighting variants on request

PUBLIC

Die satinierte Acrylabdeckung für eine homogene Lichtverteilung.

The satin-finished acrylic cover for homogeneous light distribution.

CLEAR FLAT Anbauleuchten | Surface luminaires

OFFICE									
ACRYL Prismatic prismatic	D mm	H mm	CCT	Treiber Driver	Leistung Wattage	Art.-Nr. Item No.			
	o 340	75	3000 K	ON/OFF	1750 lm/13 W	157-1530-10-30	157-1530-20-30	157-1530-30-30	
	o 340	75	4000 K	ON/OFF	1850 lm/13 W	157-1530-10-40	157-1530-20-40	157-1530-30-40	
	o 340	75	3000 K	DALI	1750 lm/13 W	157-1530-12-30	157-1530-22-30	157-1530-32-30	
	o 340	75	4000 K	DALI	1850 lm/13 W	157-1530-12-40	157-1530-22-40	157-1530-32-40	
	o 450	75	3000 K	ON/OFF	2900 lm/20 W	157-1540-10-30	157-1540-20-30	157-1540-30-30	
	o 450	75	4000 K	ON/OFF	3050 lm/20 W	157-1540-10-40	157-1540-20-40	157-1540-30-40	
	o 450	75	3000 K	DALI	2900 lm/20 W	157-1540-12-30	157-1540-22-30	157-1540-32-30	
	o 450	75	4000 K	DALI	3050 lm/20 W	157-1540-12-40	157-1540-22-40	157-1540-32-40	
	o 625	75	3000 K	ON/OFF	6650 lm/42 W	157-1560-10-30	157-1560-20-30	157-1560-30-30	
	o 625	75	4000 K	ON/OFF	7000 lm/42 W	157-1560-10-40	157-1560-20-40	157-1560-30-40	
	o 625	75	3000 K	DALI	6650 lm/42 W	157-1560-12-30	157-1560-22-30	157-1560-32-30	
	o 625	75	4000 K	DALI	7000 lm/42 W	157-1560-12-40	157-1560-22-40	157-1560-32-40	
L x B W mm									
	o 300	75	3000 K	ON/OFF	1650 lm/14 W	157-2530-10-30	157-2530-20-30	157-2530-30-30	
	o 300	75	4000 K	ON/OFF	1750 lm/14 W	157-2530-10-40	157-2530-20-40	157-2530-30-40	
	o 300	75	3000 K	DALI	1650 lm/14 W	157-2530-12-30	157-2530-22-30	157-2530-32-30	
	o 300	75	4000 K	DALI	1750 lm/14 W	157-2530-12-40	157-2530-22-40	157-2530-32-40	
	o 435	75	3000 K	ON/OFF	3440 lm/25 W	157-2540-10-30	157-2540-20-30	157-2540-30-30	
	o 435	75	4000 K	ON/OFF	3550 lm/25 W	157-2540-10-40	157-2540-20-40	157-2540-30-40	
	o 435	75	3000 K	DALI	3440 lm/25 W	157-2540-12-30	157-2540-22-30	157-2540-32-30	
	o 435	75	4000 K	DALI	3550 lm/25 W	157-2540-12-40	157-2540-22-40	157-2540-32-40	
	o 580	75	3000 K	ON/OFF	6600 lm/47 W	157-2560-10-30	157-2560-20-30	157-2560-30-30	
	o 580	75	4000 K	ON/OFF	6950 lm/47 W	157-2560-10-40	157-2560-20-40	157-2560-30-40	
	o 580	75	3000 K	DALI	6600 lm/47 W	157-2560-12-30	157-2560-22-30	157-2560-32-30	
	o 580	75	4000 K	DALI	6950 lm/47 W	157-2560-12-40	157-2560-22-40	157-2560-32-40	

IHRE WAHL

Die satinierte Acrylabdeckung (PUBLIC) für homogene Lichtverteilung oder die prismatische Abdeckung (OFFICE) für einen normgerechten Bildschirmarbeitsplatz.

YOUR CHOICE

The satin-coated acrylic cover (PUBLIC) for homogeneous light distribution or the glare reducing prismatic cover (OFFICE) for standardised computer workstation lighting.



CLEAR FLAT Pendelleuchten | Pendant luminaires

PUBLIC									
ACRYL satiniert satin-finished	D mm	H mm	CCT	Treiber Driver	Leistung Wattage	Art.-Nr. Item No.			
	o 340	75	3000 K	ON/OFF	1600 lm/13 W	167-1430-10-30	167-1430-20-30	167-1430-30-30	
	o 340	75	4000 K	ON/OFF	1700 lm/13 W	167-1430-10-40	167-1430-20-40	167-1430-30-40	
	o 340	75	3000 K	DALI	1600 lm/13 W	167-1430-12-30	167-1430-22-30	167-1430-32-30	
	o 340	75	4000 K	DALI	1700 lm/13 W	167-1430-12-40	167-1430-22-40	167-1430-32-40	
	o 450	75	3000 K	ON/OFF	2650 lm/20 W	167-1440-10-30	167-1440-20-30	167-1440-30-30	
	o 450	75	4000 K	ON/OFF	2800 lm/20 W	167-1440-10-40	167-1440-20-40	167-1440-30-40	
	o 450	75	3000 K	DALI	2650 lm/20 W	167-1440-12-30	167-1440-22-30	167-1440-32-30	
	o 450	75	4000 K	DALI	2800 lm/20 W	167-1440-12-40	167-1440-22-40	167-1440-32-40	
	o 625	75	3000 K	ON/OFF	6100 lm/42 W	167-1460-10-30	167-1460-20-30	167-1460-30-30	
	o 625	75	4000 K	ON/OFF	6450 lm/42 W	167-1460-10-40	167-1460-20-40	167-1460-30-40	
	o 625	75	3000 K	DALI	6100 lm/42 W	167-1460-12-30	167-1460-22-30	167-1460-32-30	
	o 625	75	4000 K	DALI	6450 lm/42 W	167-1460-12-40	167-1460-22-40	167-1460-32-40	
	o 850	75	3000 K	ON/OFF	11500 lm/84 W	167-1480-10-30	167-1480-20-30	167-1480-30-30	
	o 850	75	4000 K	ON/OFF	12100 lm/84 W	167-1480-10-40	167-1480-20-40	167-1480-30-40	
	o 850	75	3000 K	DALI	11500 lm/84 W	167-1480-12-30	167-1480-22-30	167-1480-32-30	
	o 850	75	4000 K	DALI	12100 lm/84 W	167-1480-12-40	167-1480-22-40	167-1480-32-40	
OFFICE									
ACRYL Prismatic prismatic									
	o 340	75	3000 K	ON/OFF	1750 lm/13 W	167-1530-10-30	167-1530-20-30	167-1530-30-30	
	o 340	75	4000 K	ON/OFF	1850 lm/13 W	167-1530-10-40	167-1530-20-40	167-1530-30-40	
	o 340	75	3000 K	DALI	1750 lm/13 W	167-1530-12-30	167-1530-22-30	167-1530-32-30	
	o 340	75	4000 K	DALI	1850 lm/13 W	167-1530-12-40	167-1530-22-40	167-1530-32-40	
	o 450	75	3000 K	ON/OFF	2900 lm/20 W	167-1540-10-30	167-1540-20-30	167-1540-30-30	
	o 450	75	4000 K	ON/OFF	3050 lm/20 W	167-1540-10-40	167-1540-20-40	167-1540-30-40	
	o 450	75	3000 K	DALI	2900 lm/20 W	167-1540-12-30	167-1540-22-30	167-1540-32-30	
	o 450	75	4000 K	DALI	3050 lm/20 W	167-1540-12-40	167-1540-22-40	167-1540-32-40	
	o 625	75	3000 K	ON/OFF	6650 lm/42 W	167-1560-10-30	167-1560-20-30	167-1560-30-30	
	o 625	75	4000 K	ON/OFF	7000 lm/42 W	167-1560-10-40	167-1560-20-40	167-1560-30-40	
	o 625	75	3000 K	DALI	6650 lm/42 W	167-1560-12-30	167-1560-22-30	167-1560-32-30	
	o 625	75	4000 K	DALI	7000 lm/42 W	167-1560-12-40	167-1560-22-40	167-1560-32-40	



Flache Anbauleuchten in verschiedenen Größen, Formen und Farben bieten jede Menge Gestaltungsfreiheit. Der dekorative Indirektanteil hellt Decken und Wände angenehm auf und lässt die Leuchte scheinbar schweben.

Flat light luminaires in various sizes, shapes and colours provide great design freedom. The decorative, indirect portion of light pleasantly brightens up ceilings and walls making luminaires appear to hover.



CLEAR DIRECT

FLÄCHIGES LICHT, DIREKT
WO MAN ES BRAUCHT

- Rein direktes Licht
- Zwei Abdeckungen zur Wahl
Acryl satiniert (PUBLIC) oder
Acryl Prismatic (OFFICE)
- Keine Staubablagerungen, besonders
geeignet für Praxen und Krankenhäuser

FLAT LIGHT, RIGHT
WHERE YOU NEED IT

- Purely direct light
- Two covers to choose from
Acryl satin-coated (PUBLIC) or
Acryl prismatic (OFFICE)
- No dust deposits, particularly
suitable for surgeries and hospitals



CLEAR DIRECT Anbauleuchten | Surface luminaires

PUBLIC	ACRYL satiniert satin-finished	D	H	CCT	Treiber	Leistung	Art.-Nr. Item No.	CRI >80	3000K	4000K	DALI	ON OFF	IP40
		mm	mm		Driver	Wattage							

	o 340	75	3000 K	ON/OFF	1550 lm/13 W	158-1430-10-30	158-1430-20-30	158-1430-30-30
	o 340	75	4000 K	ON/OFF	1600 lm/13 W	158-1430-10-40	158-1430-20-40	158-1430-30-40
	o 340	75	3000 K	DALI	1550 lm/13 W	158-1430-12-30	158-1430-22-30	158-1430-32-30
	o 340	75	4000 K	DALI	1600 lm/13 W	158-1430-12-40	158-1430-22-40	158-1430-32-40
	o 450	75	3000 K	ON/OFF	2500 lm/20 W	158-1440-10-30	158-1440-20-30	158-1440-30-30
	o 450	75	4000 K	ON/OFF	2650 lm/20 W	158-1440-10-40	158-1440-20-40	158-1440-30-40
	o 450	75	3000 K	DALI	2500 lm/20 W	158-1440-12-30	158-1440-22-30	158-1440-32-30
	o 450	75	4000 K	DALI	2650 lm/20 W	158-1440-12-40	158-1440-22-40	158-1440-32-40
	o 625	75	3000 K	ON/OFF	5800 lm/42 W	158-1460-10-30	158-1460-20-30	158-1460-30-30
	o 625	75	4000 K	ON/OFF	6100 lm/42 W	158-1460-10-40	158-1460-20-40	158-1460-30-40
	o 625	75	3000 K	DALI	5800 lm/42 W	158-1460-12-30	158-1460-22-30	158-1460-32-30
	o 625	75	4000 K	DALI	6100 lm/42 W	158-1460-12-40	158-1460-22-40	158-1460-32-40
	o 850	75	3000 K	ON/OFF	10850 lm/84 W	158-1480-10-30	158-1480-20-30	158-1480-30-30
	o 850	75	4000 K	ON/OFF	11450 lm/84 W	158-1480-10-40	158-1480-20-40	158-1480-30-40
	o 850	75	3000 K	DALI	10850 lm/84 W	158-1480-12-30	158-1480-22-30	158-1480-32-30
	o 850	75	4000 K	DALI	11450 lm/84 W	158-1480-12-40	158-1480-22-40	158-1480-32-40

L x B | W mm

	□ 300	75	3000 K	ON/OFF	1600 lm/14 W	158-2530-10-30	158-2530-20-30	158-2530-30-30
	□ 300	75	4000 K	ON/OFF	1650 lm/14 W	158-2530-10-40	158-2530-20-40	158-2530-30-40
	□ 300	75	3000 K	DALI	1600 lm/14 W	158-2530-12-30	158-2530-22-30	158-2530-32-30
	□ 300	75	4000 K	DALI	1650 lm/14 W	158-2530-12-40	158-2530-22-40	158-2530-32-40
	□ 435	75	3000 K	ON/OFF	3200 lm/25 W	158-2540-10-30	158-2540-20-30	158-2540-30-30
	□ 435	75	4000 K	ON/OFF	3400 lm/25 W	158-2540-10-40	158-2540-20-40	158-2540-30-40
	□ 435	75	3000 K	DALI	3200 lm/25 W	158-2540-12-30	158-2540-22-30	158-2540-32-30
	□ 435	75	4000 K	DALI	3400 lm/25 W	158-2540-12-40	158-2540-22-40	158-2540-32-40
	□ 580	75	3000 K	ON/OFF	6300 lm/47 W	158-2560-10-30	158-2560-20-30	158-2560-30-30
	□ 580	75	4000 K	ON/OFF	6600 lm/47 W	158-2560-10-40	158-2560-20-40	158-2560-30-40
	□ 580	75	3000 K	DALI	6300 lm/47 W	158-2560-12-30	158-2560-22-30	158-2560-32-30
	□ 580	75	4000 K	DALI	6600 lm/47 W	158-2560-12-40	158-2560-22-40	158-2560-32-40
	□ 850	75	3000 K	ON/OFF	12900 lm/107 W	158-2480-10-30	158-2580-20-30	158-2580-30-30
	□ 850	75	4000 K	ON/OFF	13550 lm/107 W	158-2480-10-40	158-2580-20-40	158-2580-30-40
	□ 850	75	3000 K	DALI	12900 lm/107 W	158-2480-12-30	158-2580-22-30	158-2580-32-30
	□ 850	75	4000 K	DALI	13550 lm/107 W	158-2480-12-40	158-2580-22-40	158-2580-32-40

Variante | Version
CLEAR DIRECT

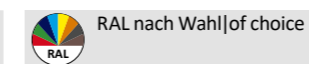

RAL nach Wahl | of choice

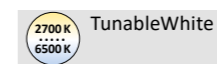

TunableWhite



Notlicht | Emergency 3h

Weitere Notlicht-Varianten auf Anfrage
Emergency lighting variants on request



CLEAR DIRECT Anbauleuchten | Surface luminaires

OFFICE ACRYL Prismatic prismatic	D mm	H mm	CCT	Treiber Driver	Leistung Wattage	Art.-Nr. Item No.							
-------------------------------------	---------	---------	-----	-------------------	---------------------	---------------------	--	--	--	--	--	--	--

	o 340	75	3000 K	ON/OFF	1700 lm/13 W	158-1530-10-30	●	●	●	●	●	●	●
	o 340	75	4000 K	ON/OFF	1750 lm/13 W	158-1530-10-40	●	●	●	●	●	●	●
	o 340	75	3000 K	DALI	1700 lm/13 W	158-1530-12-30	●	●	●	●	●	●	●
	o 340	75	4000 K	DALI	1750 lm/13 W	158-1530-12-40	●	●	●	●	●	●	●
	o 450	75	3000 K	ON/OFF	2750 lm/20 W	158-1540-10-30	●	●	●	●	●	●	●
	o 450	75	4000 K	ON/OFF	2900 lm/20 W	158-1540-10-40	●	●	●	●	●	●	●
	o 450	75	3000 K	DALI	2750 lm/20 W	158-1540-12-30	●	●	●	●	●	●	●
	o 450	75	4000 K	DALI	2900 lm/20 W	158-1540-12-40	●	●	●	●	●	●	●
	o 625	75	3000 K	ON/OFF	6350 lm/42 W	158-1560-10-30	●	●	●	●	●	●	●
	o 625	75	4000 K	ON/OFF	6650 lm/42 W	158-1560-10-40	●	●	●	●	●	●	●
	o 625	75	3000 K	DALI	6350 lm/42 W	158-1560-12-30	●	●	●	●	●	●	●
	o 625	75	4000 K	DALI	6650 lm/42 W	158-1560-12-40	●	●	●	●	●	●	●

L x B | W mm

	□ 300	75	3000 K	ON/OFF	1600 lm/14 W	158-2530-10-30	●	●	●	●	●	●	●
	□ 300	75	4000 K	ON/OFF	1650 lm/14 W	158-2530-10-40	●	●	●	●	●	●	●
	□ 300	75	3000 K	DALI	1600 lm/14 W	158-2530-12-30	●	●	●	●	●	●	●
	□ 300	75	4000 K	DALI	1650 lm/14 W	158-2530-12-40	●	●	●	●	●	●	●
	□ 435	75	3000 K	ON/OFF	3200 lm/25 W	158-2540-10-30	●	●	●	●	●	●	●
	□ 435	75	4000 K	ON/OFF	3400 lm/25 W	158-2540-10-40	●	●	●	●	●	●	●
	□ 435	75	3000 K	DALI	3200 lm/25 W	158-2540-12-30	●	●	●	●	●	●	●
	□ 435	75	4000 K	DALI	3400 lm/25 W	158-2540-12-40	●	●	●	●	●	●	●
	□ 580	75	3000 K	ON/OFF	6300 lm/47 W	158-2560-10-30	●	●	●	●	●	●	●
	□ 580	75	4000 K	ON/OFF	6600 lm/47 W	158-2560-10-40	●	●	●	●	●	●	●
	□ 580	75	3000 K	DALI	6300 lm/47 W	158-2560-12-30	●	●	●	●	●	●	●
	□ 580	75	4000 K	DALI	6600 lm/47 W	158-2560-12-40	●	●	●	●	●	●	●

PERFEKTE BALANCE

- Warme, freundliche Atmosphäre für Patienten
- Ausreichende Helligkeit und hohe Lichtqualität für das Personal
- Geringer Montage- und Wartungsaufwand für den Bauherren

THE RIGHT BALANCE

- Warm, friendly atmosphere for patients
- Sufficient brightness and high quality of light for the staff
- Low installation and maintenance costs for the owner

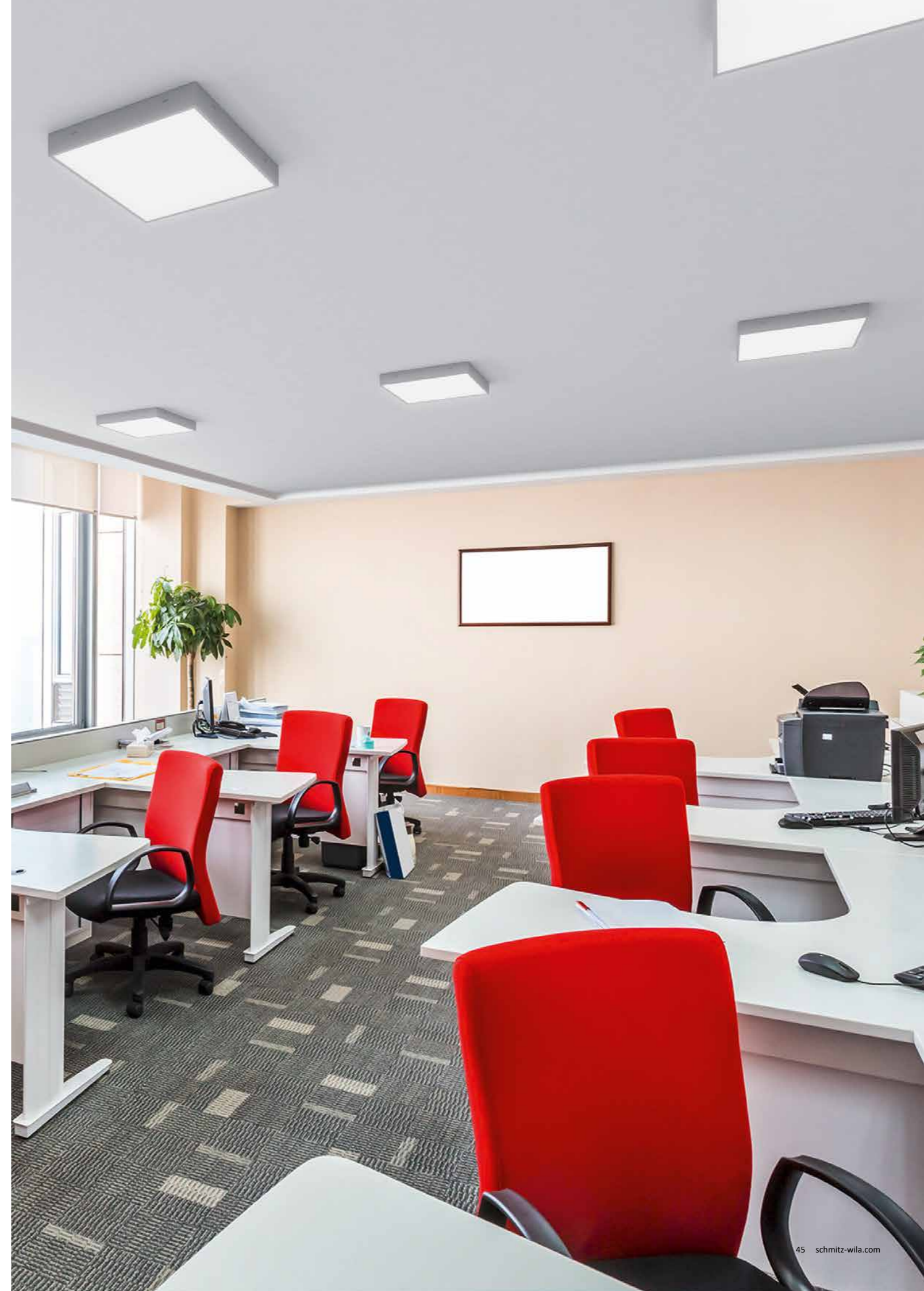

PUBLIC							
ACRYL satiniert satin-finished	D	H	CCT	Treiber Driver	Leistung Wattage	Art.-Nr. Item No.	
mm	mm	mm	K		W	○	●



	○ 340	75	3000 K	ON/OFF	1550 lm/13 W	168-1430-10-30	168-1430-20-30	168-1430-30-30
	○ 340	75	4000 K	ON/OFF	1600 lm/13 W	168-1430-10-40	168-1430-20-40	168-1430-30-40
	○ 340	75	3000 K	DALI	1550 lm/13 W	168-1430-12-30	168-1430-22-30	168-1430-32-30
	○ 340	75	4000 K	DALI	1600 lm/13 W	168-1430-12-40	168-1430-22-40	168-1430-32-40
	○ 450	75	3000 K	ON/OFF	2500 lm/20 W	168-1440-10-30	168-1440-20-30	168-1440-30-30
	○ 450	75	4000 K	ON/OFF	2650 lm/20 W	168-1440-10-40	168-1440-20-40	168-1440-30-40
	○ 450	75	3000 K	DALI	2500 lm/20 W	168-1440-12-30	168-1440-22-30	168-1440-32-30
	○ 450	75	4000 K	DALI	2650 lm/20 W	168-1440-12-40	168-1440-22-40	168-1440-32-40
	○ 625	75	3000 K	ON/OFF	5800 lm/42 W	168-1460-10-30	168-1460-20-30	168-1460-30-30
	○ 625	75	4000 K	ON/OFF	6100 lm/42 W	168-1460-10-40	168-1460-20-40	168-1460-30-40
	○ 625	75	3000 K	DALI	5800 lm/42 W	168-1460-12-30	168-1460-22-30	168-1460-32-30
	○ 625	75	4000 K	DALI	6100 lm/42 W	168-1460-12-40	168-1460-22-40	168-1460-32-40
	○ 850	75	3000 K	ON/OFF	10850 lm/84 W	168-1480-10-30	168-1480-20-30	168-1480-30-30
	○ 850	75	4000 K	ON/OFF	14450 lm/84 W	168-1480-10-40	168-1480-20-40	168-1480-30-40
	○ 850	75	3000 K	DALI	10850 lm/84 W	168-1480-12-30	168-1480-22-30	168-1480-32-30
	○ 850	75	4000 K	DALI	14450 lm/84 W	168-1480-12-40	168-1480-22-40	168-1480-32-40

L x B | W mm

	□ 300	75	3000 K	ON/OFF	1450 lm/14 W	168-2430-10-30	168-2430-20-30	168-2430-30-30
	□ 300	75	4000 K	ON/OFF	1550 lm/14 W	168-2430-10-40	168-2430-20-40	168-2430-30-40
	□ 300	75	3000 K	DALI	1450 lm/14 W	168-2430-12-30	168-2430-22-30	168-2430-32-30
	□ 300	75	4000 K	DALI	1550 lm/14 W	168-2430-12-40	168-2430-22-40	168-2430-32-40
	□ 435	75	3000 K	ON/OFF	2950 lm/25 W	168-2440-10-30	168-2440-20-30	168-2440-30-30
	□ 435	75	4000 K	ON/OFF	3100 lm/25 W	168-2440-10-40	168-2440-20-40	168-2440-30-40
	□ 435	75	3000 K	DALI	2950 lm/25 W	168-2440-12-30	168-2440-22-30	168-2440-32-30
	□ 435	75	4000 K	DALI	3100 lm/25 W	168-2440-12-40	168-2440-22-40	168-2440-32-40
	□ 580	75	3000 K	ON/OFF	5750 lm/47 W	168-2460-10-30	168-2460-20-30	168-2460-30-30
	□ 580	75	4000 K	ON/OFF	6050 lm/47 W	168-2460-10-40	168-2460-20-40	168-2460-30-40
	□ 580	75	3000 K	DALI	5750 lm/47 W	168-2460-12-30	168-2460-22-30	168-2460-32-30
	□ 580	75	4000 K	DALI	6050 lm/47 W	168-2460-12-40	168-2460-22-40	168-2460-32-40
	□ 850	75	3000 K	ON/OFF	12900 lm/107 W	168-2480-10-30	168-2480-20-30	168-2480-30-30
	□ 850	75	4000 K	ON/OFF	13550 lm/107 W	168-2480-10-40	168-2480-20-40	168-2480-30-40
	□ 850	75	3000 K	DALI	12900 lm/107 W	168-2480-12-30	168-2480-22-30	168-2480-32-30
	□ 850	75	4000 K	DALI	13550 lm/107 W	168-2480-12-40	168-2480-22-40	168-2480-32-40



OFFICE							
ACRYL Prismatik prismatic	D	H	CCT	Treiber Driver	Leistung Wattage	Art.-Nr. Item No.	
mm	mm	mm	K		W	○	●



	○ 340	75	3000 K	ON/OFF	1700 lm/13 W	168-1530-10-30	168-1530-20-30	168-1530-30-30
	○ 340	75	4000 K	ON/OFF	1700 lm/13 W	168-1530-10-40	168-1530-20-40	168-1530-30-40
	○ 340	75	3000 K	DALI	1700 lm/13 W	168-1530-12-30	168-1530-22-30	168-1530-32-30
	○ 340	75	4000 K	DALI	1700 lm/13 W	168-1530-12-40	168-1530-22-40	168-1530-32-40
	○ 450	75	3000 K	ON/OFF	2750 lm/20 W	168-1540-10-30	168-1540-20-30	168-1540-30-30
	○ 450	75	4000 K	ON/OFF	2900 lm/20 W	168-1540-10-40	168-1540-20-40	168-1540-30-40
	○ 450	75	3000 K	DALI	2750 lm/20 W	168-1540-12-30	168-1540-22-30	168-1540-32-30
	○ 450	75	4000 K	DALI	2900 lm/20 W	168-1540-12-40	168-1540-22-40	168-1540-32-40
	○ 625	75	3000 K	ON/OFF	6350 lm/42 W	168-1560-10-30	168-1560-20-30	168-1560-30-30
	○ 625	75	4000 K	ON/OFF	6650 lm/42 W	168-1560-10-40	168-1560-20-40	168-1560-30-40
	○ 625	75	3000 K	DALI	6350 lm/42 W	168-1560-12-30	168-1560-22-30	168-1560-32-30
	○ 625	75	4000 K	DALI	6650 lm/42 W	168-1560-12-40	168-1560-22-40	168-1560-32-40

L x B | W mm

	□ 300	75	3000 K	ON/OFF	1600 lm/14 W	168-2530-10-30	168-2530-20-30	168-2530-30-30
	□ 300	75	4000 K	ON/OFF	1650 lm/14 W	168-2530-10-40	168-2530-20-40	168-2530-30-40
	□ 300	75	3000 K	DALI	1600 lm/14 W	168-2530-12-30	168-2530-22-30	168-2530-32-30
	□ 300	75	4000 K	DALI	1650 lm/14 W	168-2530-12-40	168-2530-22-40	168-2530-32-40
	□ 435	75	3000 K	ON/OFF	3200 lm/25 W	168-2540-10-30	168-2540-20-30	168-2540-30-30
	□ 435	75	4000 K	ON/OFF	3400 lm/25 W	168-2540-10-40	168-2540-20-40	168-2540-30-40
	□ 435	75	3000 K	DALI	3200 lm/25 W	168-2540-12-30	168-2540-22-30	168-2540-32-30
	□ 435	75	4000 K	DALI	3400 lm/25 W	168-2540-12-40	168-2540-22-40	168-2540-32-40
	□ 580	75	3000 K	ON/OFF	6300 lm/47 W	168-2560-10-30	168-2560-20-30	168-2560-30-30
	□ 580	75	4000 K	ON/OFF	6600 lm/47 W	168-2560-10-40	168-2560-20-40	168-2560-30-40
	□ 580	75	3000 K	DALI	6300 lm/47 W	168-2560-12-30	168-2560-22-30	168-2560-32-30
	□ 580	75	4000 K	DALI	6600 lm/47 W	168-2560-12-40	168-2560-22-40	168-2560-32-40

COOL & RELAXED

Die Flure, Treppenhäuser und Relax-Zonen verfügen über einen Mix von großdimensionierten CLEAR DIRECT Anbauleuchten in einer speziellen Halbeinbauversion. Die Neigung der Leuchten um 4° sorgt zusätzlich für spannende Aspekte in der Gestaltung.

The floors, staircases and relaxation areas have a mix of grand dimensional CLEAR DIRECT surface-mounted luminaires in a special mounted version. The inclination of the luminaires by 4° additionally provides exciting aspects in the design.





CLEAR EVO

DESIGN, EFFIZIENZ UND FUNKTION

- Lichtverteilung direkt/indirekt
- Neue innovative Montagelösung: "Fast-Connect"-Kupplung
- CCT Switch 3000/3500/4000 Kelvin
- Zwei Abdeckungen zur Wahl
- Acryl satiniert oder prismatisch (UGR <19)
- Drei Konturvarianten: CLEAR EVO S mit gerader Kontur, CLEAR EVO C mit konvexer Kontur und CLEAR EVO D gerade Kontur mit Dekorstreifen
- Elektrische und mechanische Installation Plug and Play

DESIGN, EFFICIENCY AND FUNCTION

- Light distribution direct/indirect
- New innovative installation solution: "Fast Connect" coupling
- CCT Switch 3000/3500/4000 Kelvin
- Choice of two covers
- Acryl satin-finished or prismatic (UGR <19)
- Three contour variants: CLEAR EVO S with straight contour, CLEAR EVO C with convex contour and CLEAR EVO D with straight contour with decorative stripe
- Electrical and mechanical installation Plug and Play

NEUE INNOVATIVE MONTAGELÖSUNG

Sehr einfache Installation durch „Fast-Connect“-Kupplung und Bajonettverschluss

NEW INNOVATIVE INSTALLATION SOLUTION

Very easy installation thanks to "Fast Connect" coupling and bayonet lock



TAILOR MADE Farbkombination | Colour combination come closer + DECOR schwarz | black

CLEAR EVO Anbauleuchten | Surface luminaires

ACRYL satiniert | satin-finished

D mm	H mm	CCT	Treiber Driver	Leistung Wattage	Art.-Nr. Item No.				
------	------	-----	----------------	------------------	---------------------	--	--	--	--

DESIGN

S - STRAIGHT

	o 380	99	SWITCH	DALI	2541 lm/20W	169-11144-12-34	169-11144-22-34	169-11144-32-34
	o 600	99	SWITCH	DALI	5434 lm/37 W	169-11146-12-34	169-11146-22-34	169-11146-32-34
	o 900	99	SWITCH	DALI	11524 lm/76 W	169-11149-12-34	169-11149-22-34	169-11149-32-34

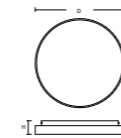

come closer live simple

C - CURVED

	o 380	99	SWITCH	DALI	2541 lm/20 W	169-12144-12-34	169-12144-22-34	169-12144-32-34
	o 600	99	SWITCH	DALI	5434 lm/37 W	169-12146-12-34	169-12146-22-34	169-12146-32-34
	o 900	99	SWITCH	DALI	11524 lm/76 W	169-12149-12-34	169-12149-22-34	169-12149-32-34

come closer live simple

	o 380	99	SWITCH	DALI	2541 lm/20 W	169-12144-42-34	169-12144-52-34	
	o 600	99	SWITCH	DALI	5434 lm/37 W	169-12146-42-34	169-12146-52-34	
	o 900	99	SWITCH	DALI	11524 lm/76 W	169-12149-42-34	169-12149-52-34	

ACRYL Prismatik | prismatic

DESIGN

S - STRAIGHT

	o 380	99	SWITCH	DALI	2480 lm/20 W	169-11154-12-34	169-11154-22-34	169-11154-32-34
	o 600	99	SWITCH	DALI	4992 lm/37 W	169-11156-12-34	169-11156-22-34	169-11156-32-34
	o 900	99	SWITCH	DALI	10210 lm/76 W	169-11159-12-34	169-11159-22-34	169-11159-32-34

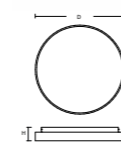

come closer live simple

C - CURVED

	o 380	99	SWITCH	DALI	2480 lm/20 W	169-12154-12-34	169-12154-22-34	169-12154-32-34
	o 600	99	SWITCH	DALI	4992 lm/37 W	169-12156-12-34	169-12156-22-34	169-12156-32-34
	o 900	99	SWITCH	DALI	10210 lm/76 W	169-12159-12-34	169-12159-22-34	169-12159-32-34

come closer live simple

	o 380	99	SWITCH	DALI	2480 lm/20 W	169-12154-42-34	169-12154-52-34	
	o 600	99	SWITCH	DALI	4992 lm/37 W	169-12156-42-34	169-12156-52-34	
	o 900	99	SWITCH	DALI	10210 lm/76 W	169-12159-42-34	169-12159-52-34	



DESIGN S DESIGN C



CLEAR EVO Pendelleuchten | Pendant luminaires

ACRYL satiniert|satin-finished

DESIGN

S - STRAIGHT

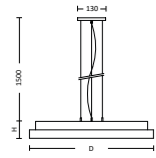

C - CURVED



D mm	H mm	CCT	Treiber Driver	Leistung Wattage	Art.-Nr. Item No.	○	●	●
○ 380	99	SWITCH	DALI	2541 lm/20W	169-21144-12-34	169-21144-22-34	169-21144-32-34	
○ 600	99	SWITCH	DALI	5434 lm/37 W	169-21146-12-34	169-21146-22-34	169-21146-32-34	
○ 900	99	SWITCH	DALI	11524 lm/76 W	169-21149-12-34	169-21149-22-34	169-21149-32-34	
						○ come closer	○ live simple	
○ 380	99	SWITCH	DALI	2541 lm/20 W	169-21144-42-34	169-21144-52-34		
○ 600	99	SWITCH	DALI	5434 lm/37 W	169-21146-42-34	169-21146-52-34		
○ 900	99	SWITCH	DALI	11524 lm/76 W	169-21149-42-34	169-21149-52-34		
						○	●	●
○ 380	99	SWITCH	DALI	2541 lm/20 W	169-22144-12-34	169-22144-22-34	169-22144-32-34	
○ 600	99	SWITCH	DALI	5434 lm/37 W	169-22146-12-34	169-22146-22-34	169-22146-32-34	
○ 900	99	SWITCH	DALI	11524 lm/76 W	169-22149-12-34	169-22149-22-34	169-22149-32-34	
						○ come closer	○ live simple	
○ 380	99	SWITCH	DALI	2541 lm/20 W	169-22144-42-34	169-22144-52-34		
○ 600	99	SWITCH	DALI	5434 lm/37 W	169-22146-42-34	169-22146-52-34		
○ 900	99	SWITCH	DALI	11524 lm/76 W	169-22149-42-34	169-22149-52-34		



ACRYL Prismatic|prismatic

DESIGN

S - STRAIGHT

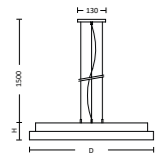

C - CURVED



D mm	H mm	CCT	Treiber Driver	Leistung Wattage	Art.-Nr. Item No.	○	●	●
○ 380	99	SWITCH	DALI	2480 lm/20 W	169-21154-12-34	169-21154-22-34	169-21154-32-34	
○ 600	99	SWITCH	DALI	4992 lm/37 W	169-21156-12-34	169-21156-22-34	169-21156-32-34	
○ 900	99	SWITCH	DALI	10210 lm/76 W	169-21159-12-34	169-21159-22-34	169-21159-32-34	
						○ come closer	○ live simple	
○ 380	99	SWITCH	DALI	2480 lm/20 W	169-21154-42-34	169-21154-52-34		
○ 600	99	SWITCH	DALI	4992 lm/37 W	169-21156-42-34	169-21156-52-34		
○ 900	99	SWITCH	DALI	10210 lm/76 W	169-21159-42-34	169-21159-52-34		
						○	●	●
○ 380	99	SWITCH	DALI	2480 lm/20 W	169-22154-12-34	169-22154-22-34	169-22154-32-34	
○ 600	99	SWITCH	DALI	4992 lm/37 W	169-22156-12-34	169-22156-22-34	169-22156-32-34	
○ 900	99	SWITCH	DALI	10210 lm/76 W	169-22159-12-34	169-22159-22-34	169-22159-32-34	
						○ come closer	○ live simple	
○ 380	99	SWITCH	DALI	2480 lm/20 W	169-22154-42-34	169-22154-52-34		
○ 600	99	SWITCH	DALI	4992 lm/37 W	169-22156-42-34	169-22156-52-34		
○ 900	99	SWITCH	DALI	10210 lm/76 W	169-22159-42-34	169-22159-52-34		



COLOR NETWORK®

Das COLORNETWORK® ist ein Netzwerk namhafter Hersteller, das jährlich neue Farbverbände über verschiedene Einrichtungsprodukte anbietet. Durch die Zusammenarbeit mit einem wechselnden Expertengremium aus Innenarchitekten, Produktdesignern und Trendexperten werden zeitlose Farbe ausgewählt, die immer wieder neu kombiniert werden können.

The COLORNETWORK® is a network of renowned manufacturers that offers new color combinations across various furnishing products every year. By working with a changing panel of experts consisting of interior designers, product designers and trend experts, timeless colors are selected that can be combined in new ways time and time again.

Die Sehnsucht nach Nähe und Geborgenheit in der Gesellschaft inspirierte die Schaffung einer sinnlichen Farbe, die tief berührt und Wärme vermittelt. Taktile Erlebnisse sind essentiell in zwischenmenschlichen Beziehungen. Die Sustained Color No.7 „come closer!“ verkörpert Emotionen und macht Materialien lebendig. Ihr facettenreicher Charakter überrascht auch Profis durch Vielseitigkeit im Materialmix.

The longing for closeness and security in society inspired the creation of a sensual color that touches deeply and conveys warmth. Tactile experiences are essential in interpersonal relationships. The sustained Color No.7 "come closer!" embodies emotions and brings materials to life. Its multifaceted character surprises even professionals with its versatility in the material mix.

Sustained Color No. 8

live simple!

Die Sustained Color No. 8 „live simple!“ ist ein inspirierender Weißton, der Raum für Neues schafft und ein Gefühl der Befreiung vermittelt. Inspiriert von der Natur und fein abgestimmt von Designexperten im COLORNETWORK® strahlt dieser Farbton Wärme aus und hat einen angenehm zurückhaltenden Charakter. „live simple!“ liebt Texturen und fließende Formen und spiegelt den Aufbruch zu mehr Natürlichkeit, Umweltbewusstsein und einem gesunden Lebensstil wider.

The sustained Color No. 8 "live simple!" is an inspiring shade of white that creates space for new things and conveys a feeling of liberation. Inspired by nature and finely tuned by design experts at COLORNETWORK®, this shade radiates warmth and has a pleasantly restrained character. "live simple!" loves textures and flowing shapes and reflects the move towards more naturalness, environmental awareness and a healthy lifestyle.





CLEAR EVO Anbauleuchten | Surface luminaires

ACRYL satiniert | satin-finished

D mm	H mm	CCT	Treiber Driver	Leistung Wattage	Art.-Nr. Item No.	<input type="radio"/>	<input type="radio"/>	<input type="radio"/>
<div style="text-align: right;"> <input checked="" type="radio"/> CRI > 90 <input checked="" type="radio"/> CCT-Switch <input checked="" type="radio"/> DALI <input checked="" type="radio"/> IP50 </div>								
DESIGN								
D - DECOR								
	o 380	99	SWITCH	DALI	2541 lm/20W	169-13144-12-34-100	169-13144-22-34-100	169-13144-32-34-100
	o 600	99	SWITCH	DALI	5434 lm/37 W	169-13146-12-34-100	169-13146-22-34-100	169-13146-32-34-100
	o 900	99	SWITCH	DALI	11524 lm/76 W	169-13149-12-34-100	169-13149-22-34-100	169-13149-32-34-100
						<input checked="" type="radio"/> come closer	<input type="radio"/> live simple	
	o 380	99	SWITCH	DALI	2541 lm/20 W	169-13144-42-34-100	169-13144-52-34-100	
	o 600	99	SWITCH	DALI	5434 lm/37 W	169-13146-42-34-100	169-13146-52-34-100	
	o 900	99	SWITCH	DALI	11524 lm/76 W	169-13149-42-34-100	169-13149-52-34-100	
						<input type="radio"/>	<input type="radio"/>	<input checked="" type="radio"/>
	o 380	99	SWITCH	DALI	2541 lm/20W	169-23144-12-34-100	169-23144-22-34-100	169-23144-32-34-100
	o 600	99	SWITCH	DALI	5434 lm/37 W	169-23146-12-34-100	169-23146-22-34-100	169-23146-32-34-100
	o 900	99	SWITCH	DALI	11524 lm/76 W	169-23149-12-34-100	169-23149-22-34-100	169-23149-32-34-100
						<input checked="" type="radio"/> come closer	<input type="radio"/> live simple	
	o 380	99	SWITCH	DALI	2541 lm/20 W	169-23144-42-34-100	169-23144-52-34-100	
	o 600	99	SWITCH	DALI	5434 lm/37 W	169-23146-42-34-100	169-23146-52-34-100	
	o 900	99	SWITCH	DALI	11524 lm/76 W	169-23149-42-34-100	169-23149-52-34-100	

ACRYL Prismatic | prismatic

D mm	H mm	CCT	Treiber Driver	Leistung Wattage	Art.-Nr. Item No.	<input type="radio"/>	<input type="radio"/>	<input type="radio"/>
<div style="text-align: right;"> <input type="radio"/> UGR < 19 <input type="radio"/> CRI > 80 <input checked="" type="radio"/> CCT-Switch <input checked="" type="radio"/> DALI <input checked="" type="radio"/> IP50 </div>								
DESIGN								
D - DECOR								
	o 380	99	SWITCH	DALI	2480 lm/20 W	169-13154-12-34-100	169-13154-22-34-100	169-13154-32-34-100
	o 600	99	SWITCH	DALI	4992 lm/37 W	169-13156-12-34-100	169-13156-22-34-100	169-13156-32-34-100
	o 900	99	SWITCH	DALI	10210 lm/76 W	169-13159-12-34-100	169-13159-22-34-100	169-13159-32-34-100
						<input checked="" type="radio"/> come closer	<input type="radio"/> live simple	
	o 380	99	SWITCH	DALI	2480 lm/20 W	169-13154-42-34-100	169-13154-52-34-100	
	o 600	99	SWITCH	DALI	4992 lm/37 W	169-13156-42-34-100	169-13156-52-34-100	
	o 900	99	SWITCH	DALI	10210 lm/76 W	169-13159-42-34-100	169-13159-52-34-100	
						<input type="radio"/>	<input type="radio"/>	<input checked="" type="radio"/>
	o 380	99	SWITCH	DALI	2480 lm/20 W	169-23154-12-34-100	169-23154-22-34-100	169-23154-32-34-100
	o 600	99	SWITCH	DALI	4992 lm/37 W	169-23156-12-34-100	169-23156-22-34-100	169-23156-32-34-100
	o 900	99	SWITCH	DALI	10210 lm/76 W	169-23159-12-34-100	169-23159-22-34-100	169-23159-32-34-100
						<input checked="" type="radio"/> come closer	<input type="radio"/> live simple	
	o 380	99	SWITCH	DALI	2480 lm/20 W	169-23154-42-34-100	169-23154-52-34-100	
	o 600	99	SWITCH	DALI	4992 lm/37 W	169-23156-42-34-100	169-23156-52-34-100	
	o 900	99	SWITCH	DALI	10210 lm/76 W	169-23159-42-34-100	169-23159-52-34-100	

* beispielhafte Abbildung in Gehäuse schwarz und Dekorstreifen Eiche

CLEAR EVO DECOR besteht aus Leuchte und Dekorstreifen bitte beides bei der Bestellung angeben.
CLEAR EVO DECOR consists of luminaire and decorative strip, please specify both when ordering.



TAILOR MADE Farbkombination | Colour combination live simple + DECOR schwarz | black

UNSERE FARBAUSWAHL FÜR SIE | OUR COLOUR SELECTION FOR YOU

Um spezielle Farbkonzepte einfach auch in der Beleuchtung fortzusetzen, haben wir mit unserem Designpartner eine Vorauswahl an Farbkombinationen erstellt. In order to simply continue special color concepts in the lighting, we have created a preselection of color combinations with our design partner.

BEISPIEL: CLEAR EVO DECOR in live simple 169-13144-52-34-100	+ Dekorstreifen Decor stripe		
		Marmor	+ 169-100-001
		Reseda Grün	+ 169-100-002
BEISPIEL: CLEAR EVO DECOR in come closer 169-13144-42-34-100	+ Dekorstreifen Decor stripe		
		Baltic Blau	+ 169-100-003
		Kaisersberg Eiche	+ 169-100-004
BEISPIEL: CLEAR EVO DECOR in weiß white 169-13144-12-34-100	+ Dekorstreifen Decor stripe		
		Lincoln Nussbaum	+ 169-100-006
		Baltic Blau	+ 169-100-003
BEISPIEL: CLEAR EVO DECOR in schwarz black 169-13144-32-34-100	+ Dekorstreifen Decor stripe		
		come closer	+ 169-100-005
		Marmor	+ 169-100-001
BEISPIEL: CLEAR EVO DECOR in silber silver 169-13144-22-34-100	+ Dekorstreifen Decor stripe		
		Apricot Braun	+ 169-100-007
		Lincoln Nussbaum	+ 169-100-006



LUNO SLIM

HOCHWERTIGE BELEUCHTUNG
MIT OBERLICHTEFFEKT

- Verschiedene Installationsmöglichkeiten und Größenvariationen
- Lichtverteilung rein direkt
- Abgerundetes, schlankes Profil
- Hocheffiziente, mikroprismatische Abdeckung

HIGH-QUALITY LIGHTING
WITH SKYLIGHT EFFECT

- Different installation options and size variations
- Light distribution purely direct
- Curved, slim profile
- High efficient microprismatic cover



LUNO SLIM Anbau- und Pendelleuchten | Surface and Pendant luminaires

ANBAU | SURFACE

D mm	H mm	CCT	Treiber Driver	Leistung W	Art.-Nr. Item No.	Art.-Nr. Item No.
484	83	3000 K	DALI	3037 lm/28 W	AR11-27W9MPDS14	AR11-27W9MPDS60
484	83	4000 K	DALI	3158 lm/28 W	AR11-27X9MPDS14	AR11-27X9MPDS60
600	83	3000 K	DALI	3956 lm/38 W	AR12-37W9MPDS14	AR12-37W9MPDS60
600	83	4000 K	DALI	4114 lm/38 W	AR12-37X9MPDS14	AR12-37X9MPDS60
896	83	3000 K	DALI	6917 lm/71 W	AR13-72W9MPDS14	AR13-72W9MPDS60
896	83	4000 K	DALI	7194 lm/71 W	AR13-72X9MPDS14	AR13-72X9MPDS60
1190	83	3000 K	DALI	9863 lm/108 W	AR14-CPW9MPDS14	AR14-CPW9MPDS60
1190	83	4000 K	DALI	10257 lm/108 W	AR14-X9MPDS14	AR14-CPX9MPDS60

PENDEL | PENDANT

D mm	H mm	CCT	Treiber Driver	Leistung W	Art.-Nr. Item No.	Art.-Nr. Item No.
484	83	3000 K	DALI	3037 lm/28 W	AR21-27W9MPDS14	AR21-27W9MPDS60
484	83	4000 K	DALI	3158 lm/28 W	AR21-27X9MPDS14	AR21-27X9MPDS60
600	83	3000 K	DALI	3956 lm/38 W	AR22-37W9MPDS14	AR22-37W9MPDS60
600	83	4000 K	DALI	4114 lm/38 W	AR22-37X9MPDS14	AR22-37X9MPDS60
896	83	3000 K	DALI	6917 lm/71 W	AR23-72W9MPDS14	AR23-72W9MPDS60
896	83	4000 K	DALI	7194 lm/71 W	AR23-72X9MPDS14	AR23-72X9MPDS60
1190	83	3000 K	DALI	9863 lm/108 W	AR24-CPW9MPDS14	AR24-CPW9MPDS60
1190	83	4000 K	DALI	10257 lm/108 W	AR24-CPX9MPDS14	AR24-CPX9MPDS60

IBERSPA-PROJEKT

UGR < 19
EFFIZIENZ | EFFICIENCY 114 lm/W

Für die drei Etagen des IBERSPA-Büros wurden Leuchten mit hohem visuellen Komfort ausgewählt, eine Casambi-Steuerung konfiguriert und darauf geachtet, dass das Tageslicht bestmöglich genutzt wird. Ein Höchstmaß an Integration und Funktionalität wurde angestrebt.

For the three floors of the IBERSPA office, luminaires with a high level of visual comfort were selected and a Casambi control system was configured. The aim was to maximise the use of light, the integration and functionality.



Iberspa, Cervera, Spanien | Design: LedsC4 co-operation Grup Charles | Foto Jordi Anguera



TZ-T

FLÄCHENBÜNDIG
PURE INTEGRATION

- Für helle, lichtdurchflutete Beleuchtungskonzepte
- Wahlweise mit oder ohne Rahmen
- Satinierte Acrylabdeckung für eine homogene Ausleuchtung

RECESSED INSTALLATION
PURE INTEGRATION

- For bright, light-flooded lighting concepts
- Optionally with or without frame
- Satinised acrylic cover for homogeneous illumination



TZ-T Einbauleuchten | Recessed luminaires

MIT RAHMEN | WITH FRAME

ACRYL satiniert|satin-finished



D mm	DA CO mm	ET RD mm	CCT	Treiber Driver	Leistung W	Art.-Nr. Item No.
------	----------	----------	-----	----------------	------------	---------------------



o 236	o 225	125	3000 K	ON/OFF	1100 lm/12 W	122-033-103
o 236	o 225	125	4000 K	ON/OFF	1150 lm/12 W	122-033-104
o 236	o 225	125	3000 K	DALI	1100 lm/12 W	122-033-123
o 236	o 225	125	4000 K	DALI	1150 lm/12 W	122-033-124

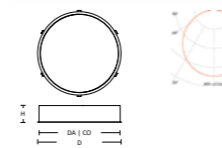

o 370	o 360	130	3000 K	ON/OFF	1450 lm/14 W	122-034-103
o 370	o 360	130	4000 K	ON/OFF	1550 lm/14 W	122-034-104
o 370	o 360	130	3000 K	DALI	1450 lm/14 W	122-034-123
o 370	o 360	130	4000 K	DALI	1550 lm/14 W	122-034-124



o 470	o 460	150	3000 K	ON/OFF	2400 lm/22 W	122-035-103
o 470	o 460	150	4000 K	ON/OFF	2500 lm/22 W	122-035-104
o 470	o 460	150	3000 K	DALI	2400 lm/22 W	122-035-123
o 470	o 460	150	4000 K	DALI	2500 lm/22 W	122-035-124

o 470	o 460	150	3000 K	ON/OFF	3850 lm/36 W	122-036-103
o 470	o 460	150	4000 K	ON/OFF	4050 lm/36 W	122-036-104
o 470	o 460	150	3000 K	DALI	3850 lm/36 W	122-036-123
o 470	o 460	150	4000 K	DALI	4050 lm/36 W	122-036-124

o 672	o 660	150	3000 K	ON/OFF	5350 lm/48 W	122-037-103
o 672	o 660	150	4000 K	ON/OFF	5600 lm/48 W	122-037-104
o 672	o 660	150	3000 K	DALI	5350 lm/48 W	122-037-123
o 672	o 660	150	4000 K	DALI	5600 lm/48 W	122-037-124

o 972	o 960	150	3000 K	ON/OFF	10650 lm/97 W	122-038-103
o 972	o 960	150	4000 K	ON/OFF	11200 lm/97 W	122-038-104
o 972	o 960	150	3000 K	DALI	10650 lm/97 W	122-038-123
o 972	o 960	150	4000 K	DALI	11200 lm/97 W	122-038-124

L x B | W mm



□ 353	□ 340	130	3000 K	ON/OFF	1150 lm/11 W	122-039-103
□ 353	□ 340	130	4000 K	ON/OFF	1200 lm/11 W	122-039-104
□ 353	□ 340	130	3000 K	DALI	1150 lm/11 W	122-039-123
□ 353	□ 340	130	4000 K	DALI	1200 lm/11 W	122-039-124

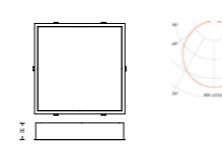

□ 477	□ 464	150	3000 K	ON/OFF	3400 lm/30 W	122-040-103
□ 477	□ 464	150	4000 K	ON/OFF	3650 lm/30 W	122-040-104
□ 477	□ 464	150	3000 K	DALI	3400 lm/30 W	122-040-123
□ 477	□ 464	150	4000 K	DALI	3650 lm/30 W	122-040-124



□ 647	□ 634	150	3000 K	ON/OFF	4650 lm/38 W	122-041-103
□ 647	□ 634	150	4000 K	ON/OFF	4800 lm/38 W	122-041-104
□ 647	□ 634	150	3000 K	DALI	4650 lm/38 W	122-041-123
□ 647	□ 634	150	4000 K	DALI	4800 lm/38 W	122-041-124

□ 938	□ 926	150	3000 K	ON/OFF	10400 lm/85 W	122-042-103
□ 938	□ 926	150	4000 K	ON/OFF	10800 lm/85 W	122-042-104
□ 938	□ 926	150	3000 K	DALI	10400 lm/85 W	122-042-123
□ 938	□ 926	150	4000 K	DALI	10800 lm/85 W	122-042-124

Variante | Version
TZ-T

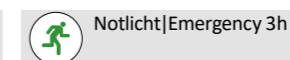

Weitere Notlicht-Varianten auf Anfrage
Emergency lighting variants on request



TZ-T Einbauleuchten | Recessed luminaires

RAHMENLOS | FRAMELESS
ACRYL satiniert | satin-finished

Art.-Nr. | Item No.

D mm	DA CO mm	ET RD mm	CCT	Treiber Driver	Leistung W	Art.-Nr. Item No.
o 220	o 225	125	3000 K	ON/OFF	1100 lm/12 W	122-112-103
o 220	o 225	125	4000 K	ON/OFF	1150 lm/12 W	122-112-104
o 220	o 225	125	3000 K	DALI	1100 lm/12 W	122-112-123
o 220	o 225	125	4000 K	DALI	1150 lm/12 W	122-112-124
o 350	o 360	100	3000 K	ON/OFF	1450 lm/14 W	122-101-103
o 350	o 360	100	4000 K	ON/OFF	1550 lm/14 W	122-101-104
o 350	o 360	100	3000 K	DALI	1450 lm/14 W	122-101-123
o 350	o 360	100	4000 K	DALI	1550 lm/14 W	122-101-124
o 450	o 460	125	3000 K	ON/OFF	2400 lm/22 W	122-102-103
o 450	o 460	125	4000 K	ON/OFF	2500 lm/22 W	122-102-104
o 450	o 460	125	3000 K	DALI	2400 lm/22 W	122-102-123
o 450	o 460	125	4000 K	DALI	2500 lm/22 W	122-102-124
o 450	o 460	125	3000 K	ON/OFF	3850 lm/36 W	122-122-103
o 450	o 460	125	4000 K	ON/OFF	4050 lm/36 W	122-122-104
o 450	o 460	125	3000 K	DALI	3850 lm/36 W	122-122-123
o 450	o 460	125	4000 K	DALI	4050 lm/36 W	122-122-124
o 650	o 665	125	3000 K	ON/OFF	5350 lm/48 W	122-103-103
o 650	o 665	125	4000 K	ON/OFF	5600 lm/48 W	122-103-104
o 650	o 665	125	3000 K	DALI	5350 lm/48 W	122-103-123
o 650	o 665	125	4000 K	DALI	5600 lm/48 W	122-103-124
o 950	o 965	125	3000 K	ON/OFF	10650 lm/97 W	122-104-103
o 950	o 965	125	4000 K	ON/OFF	11200 lm/97 W	122-104-104
o 950	o 965	125	3000 K	DALI	10650 lm/97 W	122-104-123
o 950	o 965	125	4000 K	DALI	11200 lm/97 W	122-104-124
L x B W mm						
□ 337	□ 345	100	3000 K	ON/OFF	1150 lm/11 W	122-109-103
□ 337	□ 345	100	4000 K	ON/OFF	1200 lm/11 W	122-109-104
□ 337	□ 345	100	3000 K	DALI	1150 lm/11 W	122-109-123
□ 337	□ 345	100	4000 K	DALI	1200 lm/11 W	122-109-124
□ 460	□ 470	125	3000 K	ON/OFF	3400 lm/30 W	122-123-103
□ 460	□ 470	125	4000 K	ON/OFF	3650 lm/30 W	122-123-104
□ 460	□ 470	125	3000 K	DALI	3400 lm/30 W	122-123-123
□ 460	□ 470	125	4000 K	DALI	3650 lm/30 W	122-123-124
□ 630	□ 640	125	3000 K	ON/OFF	4650 lm/38 W	122-110-103
□ 630	□ 640	125	4000 K	ON/OFF	4800 lm/38 W	122-110-104
□ 630	□ 640	125	3000 K	DALI	4650 lm/38 W	122-110-123
□ 630	□ 640	125	4000 K	DALI	4800 lm/38 W	122-110-124
□ 920	□ 930	125	3000 K	ON/OFF	10400 lm/85 W	122-111-103
□ 920	□ 930	125	4000 K	ON/OFF	10800 lm/85 W	122-111-104
□ 920	□ 930	125	3000 K	DALI	10400 lm/85 W	122-111-123
□ 920	□ 930	125	4000 K	DALI	10800 lm/85 W	122-111-124

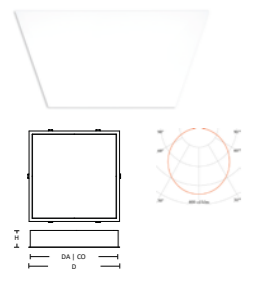
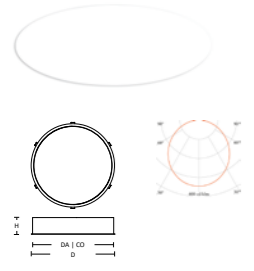



CALVIA Anbau- und Pendelleuchten | Surface and Pendant luminaires

LIGHT CONTROL STRUCTURE ANBAU SURFACE	L x B W mm	H mm	CCT	Treiber Driver	Leistung Wattage		Art.-Nr. Item No.
--	-----------------	---------	-----	-------------------	---------------------	--	---------------------



□ 400	40	-	3000 K	DALI	2500 lm/31 W		131-001-223
□ 400	40	-	4000 K	DALI	2650 lm/31 W		131-001-224
□ 600	40	-	3000 K	DALI	3850 lm/47 W		131-002-223
□ 600	40	-	4000 K	DALI	4050 lm/47 W		131-002-224

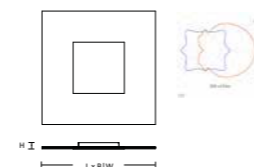

PENDEL | PENDANT

L2 x B | W2 mm



□ 400	11	□ 170	3000 K	DALI	2500 lm/31 W		131-003-223
□ 400	11	□ 170	4000 K	DALI	2650 lm/31 W		131-003-224
□ 600	11	□ 270	3000 K	DALI	3850 lm/47 W		131-004-223
□ 600	11	□ 270	4000 K	DALI	4050 lm/47 W		131-004-224

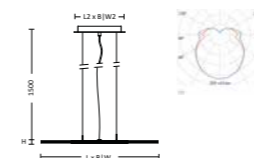

CALVIA

ELEGANTE LEICHTIGKEIT IN ULTRAFLACHEM DESIGN

- Extrem flaches Design von nur 11 mm
- Seitliche Lichteinspeisung in die Scheibe mit LCS (Light Control Structure) für eine sehr homogene Ausleuchtung
- Zentrales Quadrat aus Edelstahl, auf Wunsch individuell beschichtbar
- Pendelleuchte, 4 Stahlseile, höhenverstellbar

ELEGANT LIGHTNESS WITH ULTRA SLIM DESIGN

- Extremely flat design of only 11 mm
- Peripheral lighting at the sides of the disc with LCS (Light Control Structure) for a very homogeneous illumination
- Central square made of stainless steel, can be individually coated on request
- Pendant luminaire, 4 steel cable, height-adjustable

H 11 mm



Das extrem flache Design von nur 11 mm wird durch seitliche Lichteinspeisung in die opale Scheibe ermöglicht. Das zentrale Quadrat aus Edelstahl rückt den Fokus auf das Wesentliche. Als Wand-, Decken- und Pendelleuchte wird CALVIA zum eigenständigen Gestaltungselement im Objektbereich. Die Lichtabstrahlung nach hinten beleuchtet indirekt Decke oder Wand und setzt zusätzliche Akzente.

The extremely flat design of only 11 mm thickness becomes possible by peripheral lighting at the sides of the opal disk. The central rectangle of stainless steel draws the focus of attention to what really matters. The CALVIA becomes a design element of its own within public areas when used either as a wall, ceiling or pendant light. The emission of the light to the rear indirectly lights up the ceiling or wall and provides additional styling accents.





CLOUD

INDIVIDUELLE GESTALTUNGSMÖGLICHKEITEN DURCH FARB- UND FORMENVIELFALT

- Individuelle Akzente
- 3 Grundformen
- + Aluminiumblende oder 5 frei kombinierbare Farbeinsätze oder pur weiß

INDIVIDUAL DESIGN OPTIONS THANKS TO A VARIETY OF COLOURS AND SHAPES

- Individual accents
- 3 basic shapes
- + Aluminium cover or 5 freely combinable colour inserts or pure white



CLOUD Anbauleuchten | Surface luminaires

Leuchte inkl. Opalabdeckung Luminaire incl. opal cover	D mm	H mm	Design Cover	CCT	Treiber Driver	Leistung Wattage	Art.-Nr. Item No.
---	---------	---------	-----------------	-----	-------------------	---------------------	---------------------



FORM 1 	410	80	pur	3000 K	DALI	2000 lm/26 W	148-001-123-000
	410	80	pur	4000 K	DALI	2200 lm/26 W	148-001-124-000
	410	80	Aluminium	3000 K	DALI	2000 lm/26 W	148-001-123-001
	410	80	Aluminium	4000 K	DALI	2200 lm/26 W	148-001-124-001
	410	80	lemon	3000 K	DALI	2000 lm/26 W	148-001-123-002
	410	80	lemon	4000 K	DALI	2200 lm/26 W	148-001-124-002
	410	80	fresh orange	3000 K	DALI	2000 lm/26 W	148-001-123-003
	410	80	fresh orange	4000 K	DALI	2200 lm/26 W	148-001-124-003
	410	80	light blue	3000 K	DALI	2000 lm/26 W	148-001-123-004
	410	80	light blue	4000 K	DALI	2200 lm/26 W	148-001-124-004
	410	80	fresh green	3000 K	DALI	2000 lm/26 W	148-001-123-005
	410	80	fresh green	4000 K	DALI	2200 lm/26 W	148-001-124-005
	410	80	classic red	3000 K	DALI	2000 lm/26 W	148-001-123-006
	410	80	classic red	4000 K	DALI	2200 lm/26 W	148-001-124-006

L x B | W mm

FORM 2 	790 x 410	80	pur	3000 K	DALI	4000 lm/52 W	148-002-123-000
	790 x 410	80	pur	4000 K	DALI	4400 lm/52 W	148-002-124-000
	790 x 410	80	Aluminium	3000 K	DALI	4000 lm/52 W	148-002-123-001
	790 x 410	80	Aluminium	4000 K	DALI	4400 lm/52 W	148-002-124-001
	790 x 410	80	lemon	3000 K	DALI	4000 lm/52 W	148-002-123-002
	790 x 410	80	lemon	4000 K	DALI	4400 lm/52 W	148-002-124-002
	790 x 410	80	fresh orange	3000 K	DALI	4000 lm/52 W	148-002-123-003
	790 x 410	80	fresh orange	4000 K	DALI	4400 lm/52 W	148-002-124-003
	790 x 410	80	light blue	3000 K	DALI	4000 lm/52 W	148-002-123-004
	790 x 410	80	light blue	4000 K	DALI	4400 lm/52 W	148-002-124-004
	790 x 410	80	fresh green	3000 K	DALI	4000 lm/52 W	148-002-123-005
	790 x 410	80	fresh green	4000 K	DALI	4400 lm/52 W	148-002-124-005
	790 x 410	80	classic red	3000 K	DALI	4000 lm/52 W	148-002-123-006
	790 x 410	80	classic red	4000 K	DALI	4400 lm/52 W	148-002-124-006

FORM 3 	790 x 740	80	pur	3000 K	DALI	6000 lm/79 W	148-003-123-000
	790 x 740	80	pur	4000 K	DALI	6600 lm/79 W	148-003-124-000
	790 x 740	80	Aluminium	3000 K	DALI	6000 lm/79 W	148-003-123-001
	790 x 740	80	Aluminium	4000 K	DALI	6600 lm/79 W	148-003-124-001
	790 x 740	80	lemon	3000 K	DALI	6000 lm/79 W	148-003-123-002
	790 x 740	80	lemon	4000 K	DALI	6600 lm/79 W	148-003-124-002
	790 x 740	80	fresh orange	3000 K	DALI	6000 lm/79 W	148-003-123-003
	790 x 740	80	fresh orange	4000 K	DALI	6600 lm/79 W	148-003-124-003
	790 x 740	80	light blue	3000 K	DALI	6000 lm/79 W	148-003-123-004
	790 x 740	80	light blue	4000 K	DALI	6600 lm/79 W	148-003-124-004
	790 x 740	80	fresh green	3000 K	DALI	6000 lm/79 W	148-003-123-005
	790 x 740	80	fresh green	4000 K	DALI	6600 lm/79 W	148-003-124-005
	790 x 740	80	classic red	3000 K	DALI	6000 lm/79 W	148-003-123-006
	790 x 740	80	classic red	4000 K	DALI	6600 lm/79 W	148-003-124-006



CLOUD COLOR - LICHTDESIGN MIT SPASSFAKTOR | LIGHTING DESIGN WITH A FUN FACTOR

Perfekt z. B. für Kindergärten und in allen Bereichen, bei denen es um individuelle Farbakkente geht.

The perfect choice for kindergartens and wherever individual colour accents are called for.



2 lemon 3 fresh orange 4 light blue 5 fresh green 6 classic red

LCS (Light Control Structure)



TRANSPARENCY Pendelleuchten | Pendant luminaires

LIGHT CONTROL STRUCTURE

L mm	B W mm	H mm	CCT	Treiber Driver	Leistung Wattage	Art.-Nr. Item No.
1197	497	23	3000 K	DALI	5880 lm/55 W	TR3507501-42-30
1197	497	23	4000 K	DALI	6190 lm/55 W	TR3507501-42-40
1482	497	23	3000 K	DALI	7350 lm/69 W	TR3507502-42-30
1482	497	23	4000 K	DALI	7740 lm/69 W	TR3507502-42-40

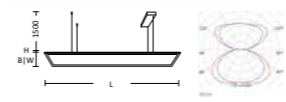

Präsenzmelder & Tageslichtsensor | Presence detector & daylight sensor

1482	497	23	3000 K	DALI	7350 lm/69 W	TR3507502-42-30-PT
1482	497	23	4000 K	DALI	7740 lm/69 W	TR3507502-42-40-PT



TunableWhite

1197	497	23	2700-6500 K	DALI	6000 lm/60 W	TR3507001-42-TW
1482	497	23	2700-6500 K	DALI	7500 lm/73 W	TR3507002-42-TW



Betriebsgerät auch als Deckeneinwurfgerät möglich
Control gear also possible inserted into the ceiling

TRANSPARENCY

PURES LICHT
MINIMALISTISCH, KLAR, ELEGANT

- Absolut homogene Ausleuchtung ohne störende Hell-/Dunkelzonen
- Light Control Structure (LCS)
- Blendungsbegrenzung < 3000 cd/m² für flexible Lichtplanungen
- Geeignet für BAP, gleichmäßige Ausleuchtung von zwei parallelen Arbeitsplätzen
- Doppel-Seilpendel mit transparenter Leitung
- Passende transparente Stehleuchte PARO

PURE LIGHT
MINIMALIST, CLEAR, ELEGANT

- Absolutely homogeneous illumination without disturbing bright/dark zones
- Light Control Structure (LCS)
- Glare-limitation < 3000 cd/m² for a flexible lighting design
- Suitable for workstations, two parallel workstations can be illuminated evenly
- Double suspension with transparent cable
- Matching floor-standing luminaire PARO

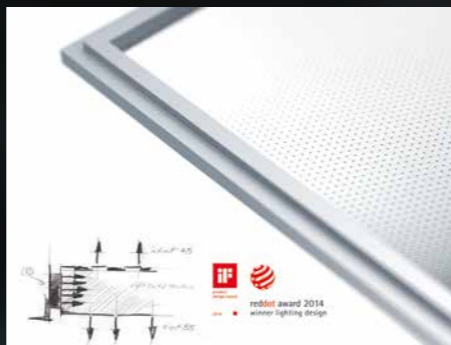

TUNABLE WHITE



BIODYNAMISCH UND INDIVIDUELL

- Per Knopfdruck die Lichtfarbe und Helligkeit unabhängig voneinander einstellbar
- Natürlicher Tageslichtverlauf: von einem Warmton in den Morgen- und Abendstunden über einen kühlen Weißton in der Mittagszeit

BIODYNAMIC AND INDIVIDUAL

- Adjusting luminous colours and levels of brightness dynamically and independently of each other
- The course of natural daylight: from warm white in the morning and evening to cool white around midday





VOLUMA

EINDRUCKSVOLLE INSZENIERUNG
TRIFFT AUF ELEGANTES DESIGN

- Einzigartige Dimensionen für große Räume mit hohen Decken, ideal für Galerien und Empfangsbereiche
- 30 Schirmfarben und 4 verschiedene Durchmesser im Standard ermöglichen volle Flexibilität und perfekte Integration im Objekt

IMPRESSIVE STAGING MEETS
ELEGANT DESIGN

- Unique dimensions for large rooms with high ceilings, ideal for galleries or lobby areas
- Maximum flexibility and perfect synthesis achieved through the choice of 30 standard shade colours and 4 diameters



VOLUMA Pendelleuchten | Pendant luminaires

Leuchtschirm weiß Lampshade white	D mm	H mm	CCT	Treiber Driver	Leistung Wattage	Art.-Nr. Item No.
	780	200	3000 K	ON/OFF	5400 lm/51 W	145-201-103
	780	200	4000 K	ON/OFF	5400 lm/51 W	145-201-104
	780	200	3000 K	DALI	5400 lm/51 W	145-201-123
	780	200	4000 K	DALI	5400 lm/51 W	145-201-124
	1150	200	3000 K	ON/OFF	9200 lm/85 W	145-202-103
	1150	200	4000 K	ON/OFF	9200 lm/85 W	145-202-104
	1150	200	3000 K	DALI	9200 lm/85 W	145-202-123
	1150	200	4000 K	DALI	9200 lm/85 W	145-202-124
	1500	300	3000 K	ON/OFF	11650 lm/108 W	145-203-103
	1500	300	4000 K	ON/OFF	11650 lm/108 W	145-203-104
	1500	300	3000 K	DALI	11650 lm/108 W	145-203-123
	1500	300	4000 K	DALI	11650 lm/108 W	145-203-124
	1850	300	3000 K	ON/OFF	15100 lm/138 W	145-204-103
	1850	300	4000 K	ON/OFF	15100 lm/138 W	145-204-104
	1850	300	3000 K	DALI	15100 lm/138 W	145-204-123
	1850	300	4000 K	DALI	15100 lm/138 W	145-204-124

Variante | Version
VOLUMA



Brandschutzqualität |
Fire protection quality +10%

Standardmäßig ist der VOLUMA Leuchtschirm in der Farbe Weiß (siehe Artikelnummern oben). Wünschen Sie einen Leuchtschirm in einer unserer 30 Schirmfarben, geben Sie die Nummer bitte hinter der Artikelnummer an: **145-20X-1XX-XXX**

The VOLUMA lampshade in white is our standard (see article numbers above). If you require a lampshade in one of our 30 shade colours, please enter the number after the article number: **145-20X-1XX-XXX**

limestone grey 425	pure white 401	classic white 402	poppy orange 420	classic red 410
urban grey 428	platinum grey 427	natural white 403	fresh orange 419	royal red 411
maron 424	carbon grey 429	light beige 404	30 farben colours	
café 426	pure black 430			

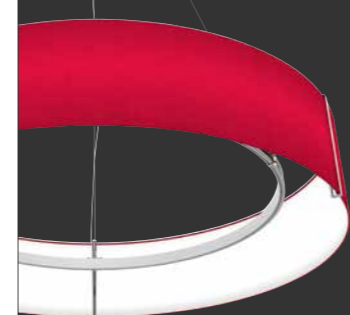

light blue 413	purple rain 407	elegant beige 421	lime green 418	racing red 409
caribbean blue 414	marina blue 415	dark beige 422	fresh green 417	fresh pink 408
royal blue 416	sand 423	lemon 405	light pink 406	

BEISPIEL | EXAMPLE:
145-201-104-410



ROTONDA

VIelfältig in der Gestaltung

- Deckenanbauleuchte, Deckenanbauleuchte mit Arm oder als Pendelleuchte
- Unterschiedliche Designs und Größen als gestalterische Basis für die perfekte Lichtlösung
- Offenes ringförmiges Design R1 + R2, R3 mit 20° geneigter Unterseite und AS mit asymmetrischer Öffnung
- Geschlossenes Design S1 und S2 mit 20° geneigten Seiten innen

VERSATILE IN DESIGN

- Ceiling luminaire, ceiling luminaire with arms or as a pendant luminaire
- Different designs and sizes for the creative base for the perfect lighting solution
- Open annular design R1 + R2, R3 with underside tapered 20° and AS with asymmetrical opening
- Closed design S1 and S2 with underside tapered 20°



Volksbank Lünen | Stoll Fotodesign, Arnsberg



ROTONDA Anbauleuchten | Surface luminaires

Leuchtschirm weiß Lampshade white	D mm	H mm	CCT	Treiber Driver	Leistung Wattage	Art.-Nr. Item No.
--------------------------------------	---------	---------	-----	-------------------	---------------------	---------------------



RING

Design R1		650	200	3000 K	DALI	3050 lm/26 W	133-001-123-107
		650	200	4000 K	DALI	3250 lm/26 W	133-001-124-107
		780	200	3000 K	DALI	4600 lm/38 W	133-002-123-108
		780	200	4000 K	DALI	4850 lm/38 W	133-002-124-108
		1000	200	3000 K	DALI	5700 lm/46 W	133-003-123-109
		1000	200	4000 K	DALI	6000 lm/46 W	133-003-124-109

Design R2		650	115	3000 K	DALI	3050 lm/26 W	133-001-123-104
		650	115	4000 K	DALI	3250 lm/26 W	133-001-124-104
		780	115	3000 K	DALI	4600 lm/38 W	133-002-123-105
		780	115	4000 K	DALI	4850 lm/38 W	133-002-124-105
		1000	115	3000 K	DALI	5700 lm/46 W	133-003-123-106
		1000	115	4000 K	DALI	6000 lm/46 W	133-003-124-106

Design R3		650	170	3000 K	DALI	3050 lm/26 W	133-001-123-114
		650	170	4000 K	DALI	3250 lm/26 W	133-001-124-114
		780	180	3000 K	DALI	4600 lm/38 W	133-002-123-115
		780	180	4000 K	DALI	4850 lm/38 W	133-002-124-115
		1000	190	3000 K	DALI	5700 lm/46 W	133-003-123-116
		1000	190	4000 K	DALI	6000 lm/46 W	133-003-124-116

ASYMMETRIC

Design AS		650	115	3000 K	DALI	4550 lm/38 W	133-021-123-124
		650	115	4000 K	DALI	4800 lm/38 W	133-021-124-124
		780	115	3000 K	DALI	5700 lm/46 W	133-022-123-125
		780	115	4000 K	DALI	6000 lm/46 W	133-022-124-125
		1000	115	3000 K	DALI	7050 lm/59 W	133-023-123-126
		1000	115	4000 K	DALI	7450 lm/59 W	133-023-124-126

SOFT

Design S1		460	60	3000 K	DALI	3100 lm/22 W	133-014-123-101
		460	60	4000 K	DALI	3250 lm/22 W	133-014-124-101
		640	60	3000 K	DALI	6800 lm/48 W	133-010-123-102
		640	60	4000 K	DALI	7150 lm/48 W	133-010-124-102
		870	60	3000 K	DALI	13600 lm/97 W	133-011-123-103
		870	60	4000 K	DALI	14300 lm/97 W	133-011-124-103

Design S2		460	100	3000 K	DALI	3100 lm/22 W	133-014-123-111
		460	100	4000 K	DALI	3250 lm/22 W	133-014-124-111
		640	115	3000 K	DALI	6800 lm/48 W	133-010-123-112
		640	115	4000 K	DALI	7150 lm/48 W	133-010-124-112
		870	120	3000 K	DALI	13600 lm/97 W	133-011-123-113
		870	120	4000 K	DALI	14300 lm/97 W	133-011-124-113

Variante Version VOLUMA	Brandschutzqualität Fire protection quality + 10%	Design RING R1, R2, R3 ASYMMETRIC AS		Design SOFT S1, S2	
------------------------------	--	---	--	--------------------	--

30 FARBEN ZUR KOMBINATION
Wünschen Sie einen Leuchtschirm in einer unserer 30 Schirmfarben, geben Sie die Nummer bitte hinter der Artikelnummer an für
SOFT S1/S2 **133-0XX-XXX-11X-XXX** oder
133-0XX-XXX-11X-XXX-XXX (außen - innen)!

30 COLOURS TO COMBINE
If you require a lampshade in one of our 30 shade colours, please enter the number after the article number for
SOFT S1/S2 **133-0XX-XXX-11X-XXX** or
133-0XX-XXX-11X-XXX-XXX (outside - inside)!

BEISPIEL | EXAMPLE:
133-010-123-102-416

außen | outside
innen | inside

BEISPIEL | EXAMPLE:
133-0202-123-115-422-413



PEARL Pendelleuchten | Pendant luminaires

PE naturweiß | natural white



D mm	H mm	CCT	Treiber Driver	Leistung Wattage	Art.-Nr. Item No.
400	1800	3000 K	ON/OFF	1850 lm/16 W	147-101-203
400	1800	4000 K	ON/OFF	1900 lm/16 W	147-101-204
400	1800	3000 K	DALI	1850 lm/16 W	147-101-223
400	1800	4000 K	DALI	1900 lm/16 W	147-101-224
500	1900	3000 K	ON/OFF	3650 lm/29 W	147-102-203
500	1900	4000 K	ON/OFF	3800 lm/29 W	147-102-204
500	1900	3000 K	DALI	3650 lm/29 W	147-102-223
500	1900	4000 K	DALI	3800 lm/29 W	147-102-224
600	2000	3000 K	ON/OFF	5450 lm/43 W	147-103-203
600	2000	4000 K	ON/OFF	5700 lm/43 W	147-103-204
600	2000	3000 K	DALI	5450 lm/43 W	147-103-223
600	2000	4000 K	DALI	5700 lm/43 W	147-103-224
770	2200	3000 K	ON/OFF	10800 lm/83 W	147-104-203
770	2200	4000 K	ON/OFF	11350 lm/83 W	147-104-204
770	2200	3000 K	DALI	10800 lm/83 W	147-104-223
770	2200	4000 K	DALI	11350 lm/83 W	147-104-224
1000	2400	3000 K	ON/OFF	13500 lm/106 W	147-105-203
1000	2400	4000 K	ON/OFF	14050 lm/106 W	147-105-204
1000	2400	3000 K	DALI	13500 lm/106 W	147-105-223
1000	2400	4000 K	DALI	14050 lm/106 W	147-105-224

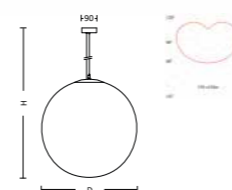

PEARL

DER KLASSIKER
HOCHWERTIGES MATERIAL,
ERSTKLASSIGE QUALITÄT

- 5 Größen von 400 bis 1.000 mm
- Kugel aus PE naturweiß für hohe Stabilität
- Homogene Ausleuchtung
- Werkzeuglos höhenverstellbare Stahlseilabhängung
- Baldachin Oberfläche chrom

THE CLASSIC
HIGH-QUALITY MATERIAL,
FIRST-CLASS QUALITY

- 5 sizes from 400 to 1.000 mm
- Ball made of PE natural white for high stability
- Homogeneous illumination
- Toolless height-adjustable steel cable suspension
- Canopy surface chrome



RETRO & MODERN

Die leuchtende Kugel übernimmt die Funktion der Allgemeinbeleuchtung, das diffuse weiche Licht mit geringer Schattenbildung schafft eine angenehme Raumwirkung. Dank ihrer verstellbaren Stahlseilabhängung lässt sich die PEARL in unterschiedlichen Höhen fixieren und die fünf Durchmesser mit bis zu einem Meter bieten viele Gestaltungsmöglichkeiten.

The luminous sphere takes on the function of general lighting, the diffuse, soft light with little shadowing creates a pleasant effect. Thanks to its adjustable steel cable suspension, the PEARL can be fixed at different heights and the five diameters of up to one metre offer many design options.





FACTORY / PARO



FACTORY



FACTORY 3



PARO

ÄSTHETISCHE STAND-ALONE-LÖSUNG

- FACTORY Lichtverteilung direkt/indirekt für zusätzliche Deckenaufhellung
- FACTORY 3 mit ihrem großen asymmetrischen Indirektanteil zur Grundbeleuchtung des Büros
- PARO, optisch filigran, LCS (Light Control Structure) für blendfreies Licht im Betrieb und transparente Optik im ausgeschalteten Zustand

AESTHETIC STAND ALONE SOLUTION

- FACTORY direct/indirect light distribution for additional ceiling illumination
- FACTORY 3 with its large asymmetrical indirect component for general lighting of the office
- PARO, visually elegant, LCS (Light Control Structure) for glare-free light during operation and transparent optics when switched off



FACTORY Stehleuchten | Floor luminaires

ACRYL Prismatic|prismatic

B W mm	L mm	H mm	H2 mm	CCT	Treiber Driver	Leistung Wattage	Art.-Nr. Item No.
-----------	---------	---------	----------	-----	-------------------	---------------------	---------------------

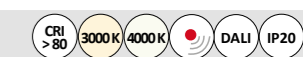

FACTORY



TOUCH DIM							
350	645	1950	62	3000 K	DALI	8000 lm/62 W	128-003-223
350	645	1950	62	4000 K	DALI	8700 lm/62 W	128-003-224



Präsenzmelder & Tageslichtsensor Presence detector & daylight sensor							
350	645	1950	62	3000 K	DIM	8000 lm/62 W	128-003-233
350	645	1950	62	4000 K	DIM	8700 lm/62 W	128-003-234

FACTORY 3



TOUCH DIM							
310	580	1965	55	3000 K	DIM	12350 lm/86 W	128-006-223
310	580	1965	55	4000 K	DIM	13000 lm/86 W	128-006-224



Präsenzmelder & Tageslichtsensor Presence detector & daylight sensor							
310	580	1965	55	3000 K	DIM	12350 lm/86 W	128-006-233
310	580	1965	55	4000 K	DIM	13000 lm/86 W	128-006-234

* 3000 K 12600 lm/100 W

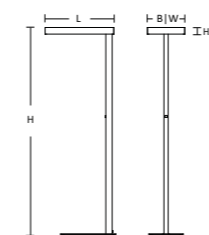

FACTORY 3

Asymmetrische Lichtverteilung in den Raum
Asymmetrical light distribution

80% indirekt | indirect / 20% direkt | direct



Variante | Version
FACTORY/FACTORY 3

RAL nach Wahl | of choice

PARO Stehleuchten | Floor luminaires

LIGHT CONTROL STRUCTURE

B W mm	L mm	H mm	CCT	Treiber Driver	Leistung Wattage	Art.-Nr. Item No.
-----------	---------	---------	-----	-------------------	---------------------	---------------------



TOUCH DIM						
445	730	1950	3000 K	DALI	6800 lm/56 W	137-001-123
445	730	1950	4000 K	DALI	7300 lm/56 W	137-001-124



Präsenzmelder & Tageslichtsensor Presence detector & daylight sensor						
445	730	1950	3000 K	DIM	6800 lm/56 W	137-001-133
445	730	1950	4000 K	DIM	7300 lm/56 W	137-001-134

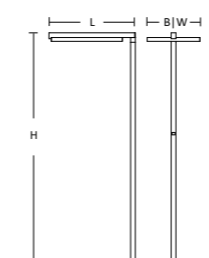

PARO

Passende transparente
Pendelleuchte
Matching pendant luminaire
TRANSPARENCY



Variante | Version
PARO

RAL nach Wahl | of choice



FACTORY SLIM

ELEGANTES ZEITLOSES DESIGN

- Extrem flacher Leuchtenkopf von nur 21 mm
- Normgerechte Ausleuchtung von Einzel- und Doppelarbeitsplätzen
- Indirektanteil (90 %) mit besonders breitstrahlenden Linearlinsen über 140° für eine gleichmäßige Raumausleuchtung
- Asymmetrisch gerichteter Direktanteil (10 %)
- Blendfreies Licht durch Prismenoptik
- Sensorik in Leuchtenkopf integriert, Tageslicht- und Bewegungssensor individuell zu- und abschaltbar
- Elegantes Design, Profil nur 60 x 30 mm

ELEGANT TIMELESS DESIGN

- Extremely flat luminaire head of only 21 mm
- Standard-compliant lighting of single and double workstations
- Indirect component (90 %) with particularly wide-beam linear lenses over 140° for uniform room illumination
- Asymmetrically direct component (10 %)
- Glare-free light thanks to prismatic optics
- Sensor system integrated in luminaire head, daylight and motion sensor can be switched on and off individually
- Elegant design, profile only 60 x 30 mm



FACTORY SLIM Steh- und Tischleuchten | Floor and Table Luminaires

ACRYL Prismatic|prismatic

B W mm	L mm	H mm	Treiber Driver	CCT	Leistung Wattage	Art.-Nr. Item No.	UGR <19	CRI >80	3000K	4000K	DALI	IP20
-----------	---------	---------	-------------------	-----	---------------------	---------------------	------------	------------	-------	-------	------	------

	320	665	2018	DIM	3000 K	16850 lm/105 W	128-6438-14-30-PT					
	320	665	2018	DIM	4000 K	17650 lm/105 W	128-6438-14-40-PT					

	320	665	2018	DIM	3000 K	8650 lm/ 53 W	128-6418-14-30-PT					
	320	665	2018	DIM	4000 K	9000 lm/ 53 W	128-6418-14-40-PT					

	320	665	1278	DIM	3000 K	16850 lm/105 W	128-5438-14-30-PT					
	320	665	1278	DIM	4000 K	17650 lm/105 W	128-5438-14-40-PT					

	320	665	1278	DIM	3000 K	8650 lm/ 53 W	128-5418-14-30-PT					
	320	665	1278	DIM	4000 K	9000 lm/ 53 W	128-5418-14-40-PT					

Variante | Version
FACTORY SLIM

RAL nach Wahl | of choice

LICHT NACH BEDARF

So vielschichtig die Aufgaben im Büro sind, so vielseitig ist die Beleuchtung. Vom konzentrierten Arbeitslicht bis zum atmosphärischen Kommunikationslicht. Dies verlangt nach flexiblen und individuellen Lichtlösungen.

LIGHT AS REQUIRED

As complex as the tasks in the office are, so is the lighting. From concentrated working light to atmospheric communication light. This calls for flexible and customised lighting solutions.



VELTO

IDEAL FÜR DOPPELARBEITSPLÄTZE

- 70° Ausstrahlungswinkel des indirekten Lichtanteils, effizient und gleichmäßig
- Sensorik in Leuchtenkopf integriert, Tageslicht- und Bewegungssensor individuell zu- und abschaltbar (beide AN, beide AUS, AN/AUS, beide individuell dimmbar), Erfassungsbereich 3 m
- CCT Switch am Leuchtenkopf einstellbar 3000/4000 K
- Komfortable Touch-Bedienung
- Elegantes Design, Profil nur 50 x 40 mm
- Beste Entblendung

IDEAL FOR DOUBLE WORKPLACES

- 70° beam angle of the indirect light component, efficient and uniform
- Sensor technology integrated in luminaire head, daylight and motion sensor can be individually switched on and off (both ON, both OFF, ON/OFF, both individually dimmable), detection range up to 3 m
- CCT switch on luminaire head 3000/4000 K
- Comfortable touch operation
- Elegant design, profile only 50 x 40 mm
- Optimised glare control



VELTO Steh- und Tischleuchten | Floor and Table Luminaires

Linse mit Reflektor
Lens with reflector

B|W L H Treiber CCT/Leistung
mm mm mm Driver Wattage

Art.-Nr./Item No.



50 1205 1960 DALI 3000 K/12600 lm 4000 K/13400 lm 100 W

VEL3-6708-12-CS-PT VEL3-6708-22-CS-PT VEL3-6708-32-CS-PT

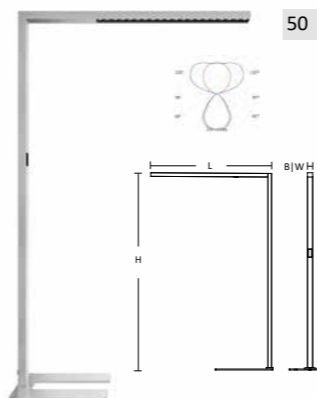

50 1205 1210 DALI 3000 K/12600 lm 4000 K/13400 lm 100 W

VEL3-5708-12-CS-PT VEL3-5708-22-CS-PT VEL3-5708-32-CS-PT

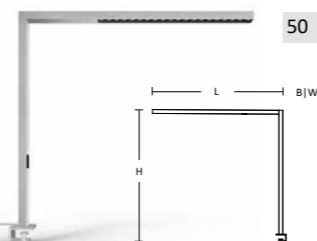

HÖCHSTE LICHTQUALITÄT UND ELEGANTES DESIGN

Der extrem breitstrahlende Lichtanteil sorgt für eine gute Gleichmäßigkeit auf dem Schreibtisch. Dank modernster Micro-Reflektortechnik bieten die Steh- und Tischleuchten eine optimale Entblendung (UGR < 13). Das dezente und professionelle Design sorgt für eine durchgängige Gestaltung und harmonische Optik in Ihrem Büro.

HIGHEST QUALITY OF LIGHT AND ELEGANT DESIGN

The extremely wide light distribution ensures good uniformity on the desk. Thanks to state-of-the-art micro-reflector technology, the free-standing and table luminaires offer optimum glare control (UGR < 13). The discreet and professional design creates a consistent design and harmonious look in your office.





STRONG 30

ENDLOSE OPTIONEN, FILIGRANE OPTIK, SCHNELLE INSTALLATION

- Nur 30 mm breites Aluminiumprofil
- 2 Farbausführungen weiß matt oder schwarz matt
- Optimale Akzentuierung durch filigrane Strahler und Pendelleuchten
- Perfekt entblendete Micro-Reflektoren, geeignet für Bildschirmarbeitsplätze
- Freie Positionierung, individuelle Linienführung, umfangreiche Geometrien

ENDLESS OPTIONS, FILIGREE LOOK, QUICK INSTALLATION

- Only 30 mm wide aluminium profile
- 2 colours available matt white or matt black
- Optimal accent lighting with filigree spotlights and pendant luminaires
- Perfect glare-free micro reflectors, suitable for computer workstations
- Free positioning, individual lines, wide variety of geometries



STRONG 30 48 V Schienensystem | 48 V track system

LEUCHTENEINSATZ LUMINAIRE INSERT	D mm	H mm	L mm	CCT	Treiber Driver	Leistung Wattage	Art.-Nr./Item No.	CRI >90	3000 K	DALI	IP20
-------------------------------------	---------	---------	---------	-----	-------------------	---------------------	-------------------	------------	--------	------	------

PENDEL | PENDANT



30	300	-	3000 K	DALI	670 lm/7 W	S30-1101-12-30	S30-1101-32-30
52	200	-	3000 K	DALI	1950 lm/18 W	S30-1113-12-30	S30-1113-32-30

STRAHLER | SPOTLIGHT



30	60	-	3000 K	DALI	670 lm/7 W	S30-1201-12-30	S30-1201-32-30
52	90	-	3000 K	DALI	1450 lm/13 W	S30-1202-12-30	S30-1202-32-30
52	140	-	3000 K	DALI	1950 lm/18 W	S30-1203-12-30	S30-1203-32-30



95	33	-	3000 K	DALI	1450 lm/13 W	S30-1204-12-30	S30-1204-32-30
----	----	---	--------	------	--------------	----------------	----------------

MICRO-REFLEKTOREN MICRO REFLECTORS



25	46	203	3000 K	DALI	1000 lm/10 W	-	S30-4103-32-30
----	----	-----	--------	------	--------------	---	----------------



25	106	203	3000 K	DALI	1000 lm/10 W	S30-4213-12-30	S30-4213-32-30
----	-----	-----	--------	------	--------------	----------------	----------------



25	57	203	3000 K	DALI	1000 lm/10 W	-	S30-4303-32-30
----	----	-----	--------	------	--------------	---	----------------

COVER OPAL



25	46	203	3000 K	DALI	690 lm/6 W	-	S30-4402-32-30
25	46	405	3000 K	DALI	1326 lm/10 W	-	S30-4403-32-30

ZUBEHÖR | ACCESSORIES (Pendel | Pendant / Strahler | Spotlight) D 52 mm

	Linse Lens α 15°	S30-8100
	Linse Lens α 50°	S30-8101
	Wabenraster Honeycomb louvre LOR 75 %	S30-8102

MINIMAL DESIGN

Trotz der kleinen Dimensionen überzeugt das 48 V Schienensystem durch kraftvolles und gleichzeitig blendfreies Licht zur Allgemein- und exzellenten Akzentbeleuchtung.

Despite its small dimensions, the 48V track system convinces with its powerful, glare-free illumination for general and excellent accent lighting.



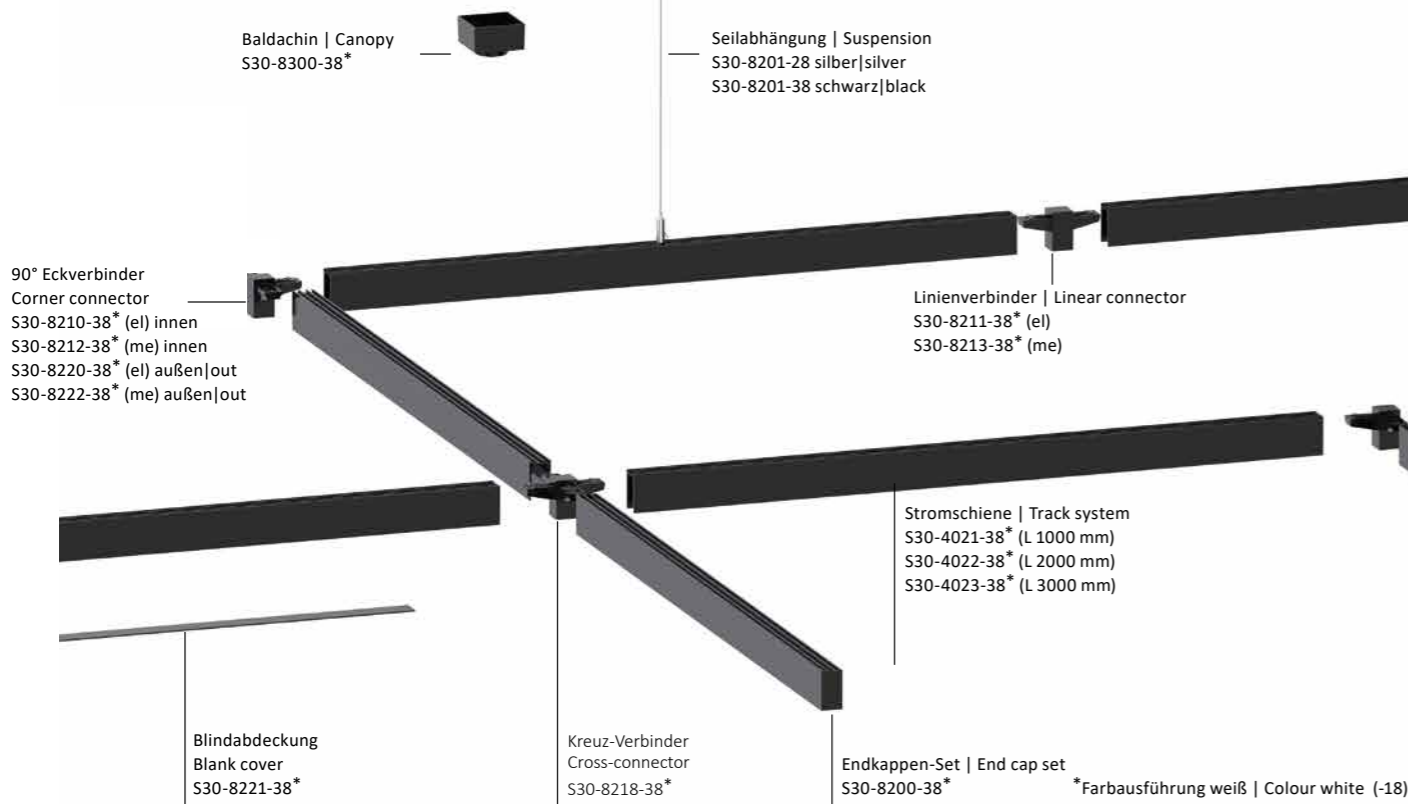

MONTAGETECHNIK | INSTALLATION TECHNIQUE

LINEARE STROMSCHIENEN Montageart Anbau- oder Pendel | LINEAR TRACK SYSTEM for surface or pendant mounting

L x B W x H 1000 x 30 x 54 mm	Art.-Nr. Item No.	S30-4021-18	S30-4021-38
L x B W x H 2000 x 30 x 54 mm		S30-4022-18	S30-4022-38
L x B W x H 3000 x 30 x 54 mm		S30-4023-18	S30-4023-38

ZUBEHOR STROMSCHIENE | ACCESSORIES TRACK SYSTEM

Linienverbinder elektrisch Linear connector electrical	Art.-Nr. Item No.	S30-8211-18	S30-8211-38
Linienverbinder mechanisch Linear connector mechanical		S30-8213-18	S30-8213-38
90° Eckverbinder elektrisch 90° Corner connector electrical		S30-8210-18	S30-8210-38
90° Eckverbinder mechanisch 90° Corner connector mechanical		S30-8212-18	S30-8212-38
90° Eckverbinder auen elektrisch 90° Outer corner connector electrical		S30-8220-18	S30-8220-38
90° Eckverbinder auen mechanisch 90° Outer corner connector mechanical		S30-8222-18	S30-8222-38
Verbinder Innenecke 90° mechanisch Inner corner connector 90° mechanical		S30-8214-18	S30-8214-38
Verbinder Auenecke 90° mechanisch Outer corner connector 90° mechanical		S30-8215-18	S30-8215-38
T-Verbinder elektrisch T-Connector electrical		S30-8216-18	S30-8216-38
T-Verbinder mechanisch T-Connector mechanical		S30-8217-18	S30-8217-38
Kreuz-Verbinder elektrisch Cross-Connector electrical		S30-8218-18	S30-8218-38
Endkappen-Set, 2 Stuck End cap, set of 2		S30-8200-18 ¹⁾	S30-8200-38
Blindabdeckung 1000 mm, beliebig kurzbar Blank cover 1000 mm, to be shortened on site		S30-8221-18	S30-8221-38
Seilabhangung, 1 Stuck Suspension, 1 piece 1500 mm		S30-8201-28	S30-8201-38
Baldachin Canopy		S30-8300-18	S30-8300-38

¹⁾ Farbe silber | Colour silver

GIPSELEMENTE | GYPSUM ELEMENTS

1000 mm Gipskanal Channel	Art.-Nr. Item No.	S30-40001
2000 mm Gipskanal Channel		S30-40002
90° Eckverbinder Corner connector		S30-40122

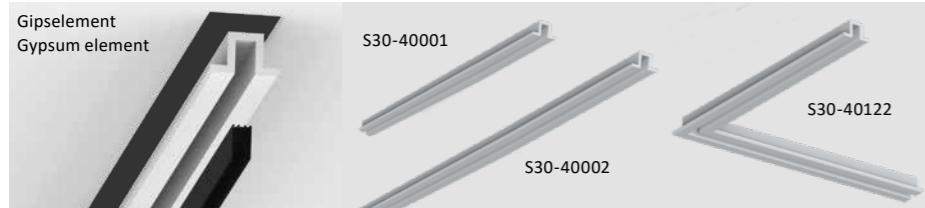

PERFECTE RAUMINTEGRATION
Gipselemente, die das Schienensystem in Wand oder Deckenkonstruktionen integrieren.

PERFECT ROOM INTEGRATION
Gypsum elements that integrate the rail system into wall or ceiling structures.

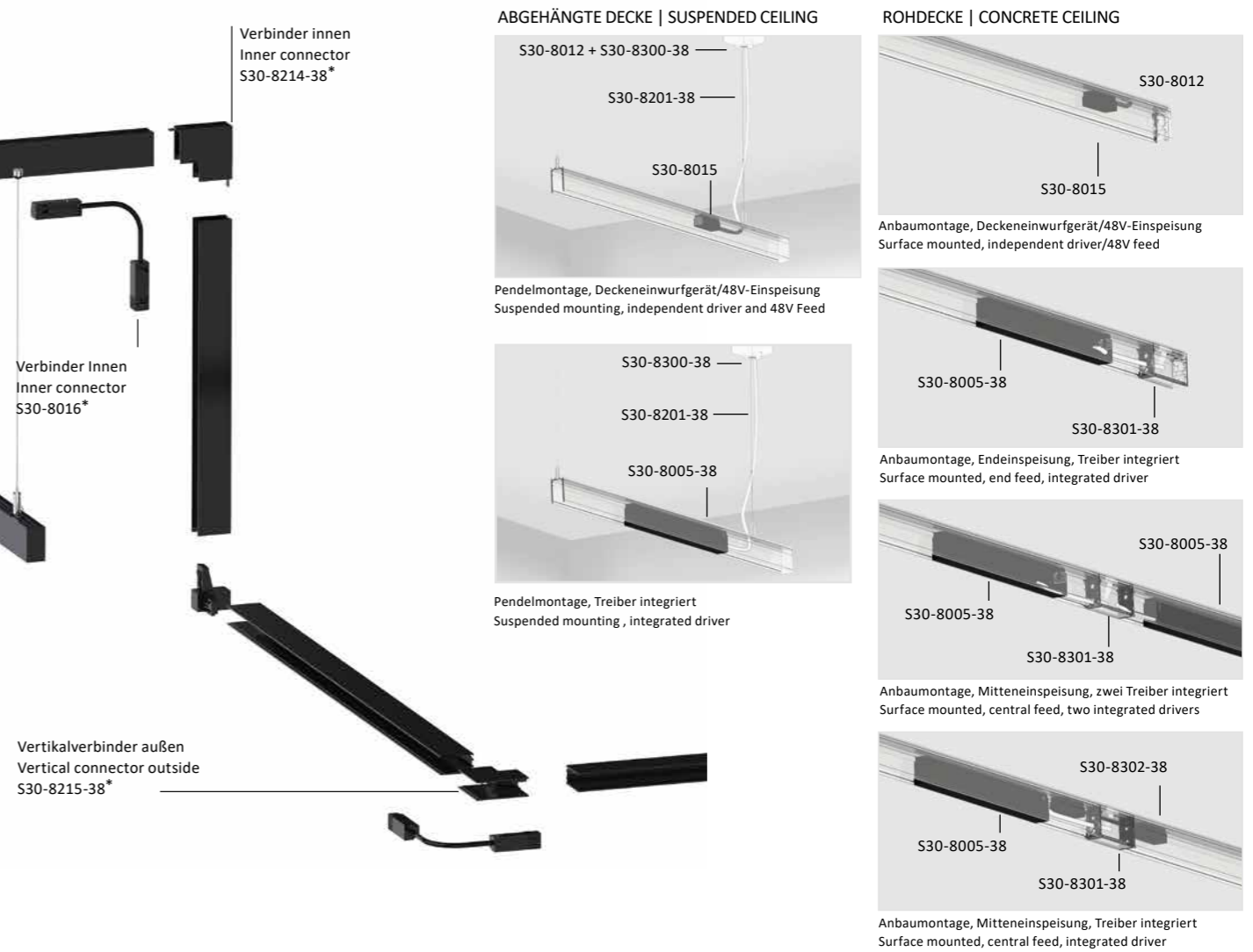

BETRIEBSTECHNIK | INSTALLATION TECHNIQUE

TREIBER | DRIVER 48 V 150 W

zur Integration, 1500 mm Zuleitung for integration, 1500 mm cable	Art.-Nr. Item No.	S30-8005-18	S30-8005-38
48 V Einspeisung mit 1500 mm Zuleitung Feed with cable		-	S30-8015 ²⁾
48 V Verbinder Innenecke Connector for inner corner		-	S30-8016 ²⁾

TREIBER | DRIVER 48 V 150 W fur Deckeneinwurf | independant

48 V Kit zur Mitteneinspeisung Deckenanbau Central feed, ceiling mounting	Art.-Nr. Item No.	S30-8302-18	S30-8302-38
---	---------------------	-------------	-------------

¹⁾ separate Anschlussbox erforderlich | Separate gear-box required

²⁾ Ausfuhrung farbneutral | Colour neutral

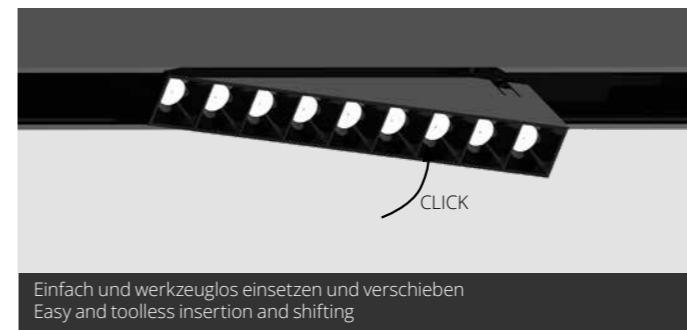

Einfach und werkzeuglos einsetzen und verschieben
Easy and toolless insertion and shifting



Treiber integriert | Driver integrated



INFINITE SLIM

MINIATURISIERUNG UND INTEGRATIVE BELEUCHTUNG

- Nur 25 mm breit
- Hoher visueller Komfort
- Breitwinkel-Optik
- Mechanische und elektronische "Click & Go"-Verbindung
- Micro Reflektoren in Silber und Schwarz

MINIATURISATION AND INTEGRATIVE LIGHTING

- Only 25 mm wide
- High visual comfort
- Wide-angle optics
- Mechanical and electrical "Click & Go" connection
- Micro reflectors in silver and black

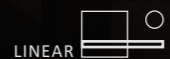

INFINITE SLIM Anbauleuchten | Surface luminaires

GRUNDLEUCHE | BASIC LUMINAIRE

MICRO REFLEKTOR	Farbe	L	B W	H	CCT	Treiber	Leistung	Art.-Nr. Item No.	
Colour	mm	mm	mm	K	Driver	Wattage			

EINZELLEUCHE SINGLE LUMINAIRE		1680	25	60	3000 K	ON/OFF	5221 lm/43 W	BB19-44W9GMOS14	BB19-44W9GMOS16	BB19-44W9GMOS60
		1680	25	60	4000 K	ON/OFF	5496 lm/43 W	BB19-44X9GMOS14	BB19-44X9GMOS16	BB19-44X9GMOS60
		1680	25	60	3000 K	DALI	5221 lm/43 W	BB19-44W9GMDS14	BB19-44W9GMDS16	BB19-44W9GMDS60
		1680	25	60	4000 K	DALI	5496 lm/43 W	BB19-44X9GMDS14	BB19-44X9GMDS16	BB19-44X9GMDS60

GRUNDLEUCHE BASIC LUMINAIRE		1680	25	60	3000 K	ON/OFF	4423 lm/43 W	BB19-44W9NMOS14	BB19-44W9NMOS16	BB19-44W9NMOS60
		1680	25	60	4000 K	ON/OFF	4656 lm/43 W	BB19-44X9NMOS14	BB19-44X9NMOS16	BB19-44X9NMOS60
		1680	25	60	3000 K	DALI	4423 lm/43 W	BB19-44W9NMDS14	BB19-44W9NMDS16	BB19-44W9NMDS60
		1680	25	60	4000 K	DALI	4656 lm/43 W	BB19-44X9NMDS14	BB19-44X9NMDS16	BB19-44X9NMDS60

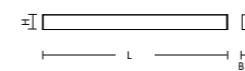

Refl. silber|silver



Refl. schwarz|black

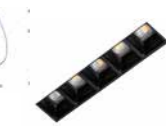

ERWEITERUNG EXTENSION		1120	25	60	3000 K	ON/OFF	3481 lm/29 W	BB11-29W9GMOS14	BB11-29W9GMOS16	BB11-29W9GMOS60
		1120	25	60	4000 K	ON/OFF	3664 lm/29 W	BB11-29X9GMOS14	BB11-29X9GMOS16	BB11-29X9GMOS60
		1120	25	60	3000 K	DALI	3481 lm/29 W	BB11-29W9GMDS14	BB11-29W9GMDS16	BB11-29W9GMDS60
		1120	25	60	4000 K	DALI	3664 lm/29 W	BB11-29X9GMDS14	BB11-29X9GMDS16	BB11-29X9GMDS60

ERWEITERUNG EXTENSION		1120	25	60	3000 K	ON/OFF	2949 lm/29 W	BB11-29W9NMOS14	BB11-29W9NMOS16	BB11-29W9NMOS60
		1120	25	60	4000 K	ON/OFF	3104 lm/29 W	BB11-29X9NMOS14	BB11-29X9NMOS16	BB11-29X9NMOS60
		1120	25	60	3000 K	DALI	2949 lm/29 W	BB11-29W9NMDS14	BB11-29W9NMDS16	BB11-29W9NMDS60
		1120	25	60	4000 K	DALI	3104 lm/29 W	BB11-29X9NMDS14	BB11-29X9NMDS16	BB11-29X9NMDS60

ERWEITERUNG EXTENSION		1680	25	60	3000 K	ON/OFF	5221 lm/43 W	BB15-29W9GMOS14	BB15-29W9GMOS16	BB15-29W9GMOS60
		1680	25	60	4000 K	ON/OFF	5496 lm/43 W	BB15-29X9GMOS14	BB15-29X9GMOS16	BB15-29X9GMOS60
		1680	25	60	3000 K	DALI	5221 lm/43 W	BB15-29W9GMDS14	BB15-29W9GMDS16	BB15-29W9GMDS60
		1680	25	60	4000 K	DALI	5496 lm/43 W	BB15-29X9GMDS14	BB15-29X9GMDS16	BB15-29X9GMDS60

ERWEITERUNG EXTENSION		1680	25	60	3000 K	ON/OFF	4423 lm/43 W	BB15-29W9NMOS14	BB15-29W9NMOS16	BB15-29W9NMOS60
		1680	25	60	4000 K	ON/OFF	4656 lm/43 W	BB15-29X9NMOS14	BB15-29X9NMOS16	BB15-29X9NMOS60
		1680	25	60	3000 K	DALI	4423 lm/43 W	BB15-29W9NMDS14	BB15-29W9NMDS16	BB15-29W9NMDS60
		1680	25	60	4000 K	DALI	4656 lm/43 W	BB15-29X9NMDS14	BB15-29X9NMDS16	BB15-29X9NMDS60

ERWEITERUNG EXTENSION		2880	25	60	3000 K	ON/OFF	8702 lm/71 W	BB17-29W9GMOS14	BB17-29W9GMOS16	BB17-29W9GMOS60
		2880	25	60	4000 K	ON/OFF	9160 lm/71 W	BB17-29X9GMOS14	BB17-29X9GMOS16	BB17-29X9GMOS60
		2880	25	60	3000 K	DALI	8702 lm/71 W	BB17-29W9GMDS14	BB17-29W9GMDS16	BB17-29W9GMDS60
		2880	25	60	4000 K	DALI	9160 lm/71 W	BB17-29X9GMDS14	BB17-29X9GMDS16	BB17-29X9GMDS60

ERWEITERUNG EXTENSION		2880	25	60	3000 K	ON/OFF	7372 lm/71 W	BB17-29W9NMOS14	BB17-29W9NMOS16	BB17-29W9NMOS60
		2880	25	60	4000 K	ON/OFF	7760 lm/71 W	BB17-29X9NMOS14	BB17-29X9NMOS16	BB17-29X9NMOS60
		2880	25	60	3000 K	DALI	7372 lm/71 W	BB17-29W9NMDS14	BB17-29W9NMDS16	BB17-29W9NMDS60
		2880	25	60	4000 K	DALI	7760 lm/71 W	BB17-29X9NMDS14	BB17-29X9NMDS16	BB17-29X9NMDS60

ERWEITERUNG EXTENSION		2880	25	60	3000 K	ON/OFF	8702 lm/71 W	BB17-29W9GMOS14	BB17-29W9GMOS16	BB17-29W9GMOS60
		2880	25	60	4000 K	ON/OFF	9160 lm/71 W	BB17-29X9GMOS14	BB17-29X9GMOS16	BB17-29X9GMOS60
		2880	25	60	3000 K	DALI	8702 lm/71 W	BB17-29W9GMDS14	BB17-29W9GMDS16	BB17-29W9GMDS60
		2880	25	60	4000 K	DALI	9160 lm/71 W	BB17-29X9GMDS14	BB17-29X9GMDS16	BB17-29X9GMDS60

ERWEITERUNG EXTENSION		2880	25	60	3000 K	ON/OFF	7372 lm/71 W	BB17-29W9NMOS14	BB17-29W9NMOS16	BB17-29W9NMOS60
		2880	25	60	4000 K	ON/OFF	7760 lm/71 W	BB17-29X9NMOS14	BB17-29X9NMOS16	BB17-29X9NMOS60
		2880	25	60	3000 K	DALI	7372 lm/71 W	BB17-29W9NMDS14	BB17-29W9NMDS16	BB17-29W9NMDS60
		2880	25	60	4000 K	DALI	7760 lm/71 W	BB17-29X9NMDS14	BB17-29X9NMDS16	BB17-29X9NMDS60



GRUNDLEUCHTE | BASIC LUMINAIRE

MICRO REFLEKTOR Farbe	L	B W	H	CCT	Treiber	Leistung	Art.-Nr.	Item No.
Colour	mm	mm	mm		Driver	Wattage		



EINZELLEUCHE
SINGLE LUMINAIRE



1680	25	60	3000 K	ON/OFF	5221 lm/43 W		BB21-44W9GMOS14	BB21-44W9GMOS16	BB21-44W9GMOS60
1680	25	60	4000 K	ON/OFF	5496 lm/43 W		BB21-44X9GMOS14	BB21-44X9GMOS16	BB21-44X9GMOS60
1680	25	60	3000 K	DALI	5221 lm/43 W		BB21-44W9GMDS14	BB21-44W9GMDS16	BB21-44W9GMDS60
1680	25	60	4000 K	DALI	5496 lm/43 W		BB21-44X9GMDS14	BB21-44X9GMDS16	BB21-44X9GMDS60



1680	25	60	3000 K	ON/OFF	4423 lm/43 W		BB21-44W9NMOS14	BB21-44W9NMOS16	BB21-44W9NMOS60
1680	25	60	4000 K	ON/OFF	4656 lm/43 W		BB21-44X9NMOS14	BB21-44X9NMOS16	BB21-44X9NMOS60
1680	25	60	3000 K	DALI	4423 lm/43 W		BB21-44W9NMDS14	BB21-44W9NMDS16	BB21-44W9NMDS60
1680	25	60	4000 K	DALI	4656 lm/43 W		BB21-44X9NMDS14	BB21-44X9NMDS16	BB21-44X9NMDS60



GRUNDLEUCHTE
BASIC LUMINAIRE



1120	25	60	3000 K	ON/OFF	3481 lm/29 W		BB12-29W9GMOS14	BB12-29W9GMOS16	BB12-29W9GMOS60
1120	25	60	4000 K	ON/OFF	3664 lm/29 W		BB12-29X9GMOS14	BB12-29X9GMOS16	BB12-29X9GMOS60
1120	25	60	3000 K	DALI	3481 lm/29 W		BB12-29W9GMDS14	BB12-29W9GMDS16	BB12-29W9GMDS60
1120	25	60	4000 K	DALI	3664 lm/29 W		BB12-29X9GMDS14	BB12-29X9GMDS16	BB12-29X9GMDS60



1120	25	60	3000 K	ON/OFF	2949 lm/29 W		BB12-29W9NMOS14	BB12-29W9NMOS16	BB12-29W9NMOS60
1120	25	60	4000 K	ON/OFF	3104 lm/29 W		BB12-29X9NMOS14	BB12-29X9NMOS16	BB12-29X9NMOS60
1120	25	60	3000 K	DALI	2949 lm/29 W		BB12-29W9NMDS14	BB12-29W9NMDS16	BB12-29W9NMDS60
1120	25	60	4000 K	DALI	3104 lm/29 W		BB12-29X9NMDS14	BB12-29X9NMDS16	BB12-29X9NMDS60

ERWEITERUNG
EXTENSION



1120	25	60	3000 K	ON/OFF	3481 lm/29 W		BB14-29W9GMOS14	BB14-29W9GMOS16	BB14-29W9GMOS60
1120	25	60	4000 K	ON/OFF	3664 lm/29 W		BB14-29X9GMOS14	BB14-29X9GMOS16	BB14-29X9GMOS60
1120	25	60	3000 K	DALI	3481 lm/29 W		BB14-29W9GMDS14	BB14-29W9GMDS16	BB14-29W9GMDS60
1120	25	60	4000 K	DALI	3664 lm/29 W		BB14-29X9GMDS14	BB14-29X9GMDS16	BB14-29X9GMDS60



1120	25	60	3000 K	ON/OFF	2949 lm/29 W		BB14-29W9NMOS14	BB14-29W9NMOS16	BB14-29W9NMOS60
1120	25	60	4000 K	ON/OFF	3104 lm/29 W		BB14-29X9NMOS14	BB14-29X9NMOS16	BB14-29X9NMOS60
1120	25	60	3000 K	DALI	2949 lm/29 W		BB14-29W9NMDS14	BB14-29W9NMDS16	BB14-29W9NMDS60
1120	25	60	4000 K	DALI	3104 lm/29 W		BB14-29X9NMDS14	BB14-29X9NMDS16	BB14-29X9NMDS60



1680	25	60	3000 K	ON/OFF	5221 lm/43 W		BB16-29W9GMOS14	BB16-29W9GMOS16	BB16-29W9GMOS60
1680	25	60	4000 K	ON/OFF	5496 lm/43 W		BB16-29X9GMOS14	BB16-29X9GMOS16	BB16-29X9GMOS60
1680	25	60	3000 K	DALI	5221 lm/43 W		BB16-29W9GMDS14	BB16-29W9GMDS16	BB16-29W9GMDS60
1680	25	60	4000 K	DALI	5496 lm/43 W		BB16-29X9GMDS14	BB16-29X9GMDS16	BB16-29X9GMDS60



1680	25	60	3000 K	ON/OFF	4423 lm/43 W		BB16-29W9NMOS14	BB16-29W9NMOS16	BB16-29W9NMOS60
1680	25	60	4000 K	ON/OFF	4656 lm/43 W		BB16-29X9NMOS14	BB16-29X9NMOS16	BB16-29X9NMOS60
1680	25	60	3000 K	DALI	4423 lm/43 W		BB16-29W9NMDS14	BB16-29W9NMDS16	BB16-29W9NMDS60
1680	25	60	4000 K	DALI	4656 lm/43 W		BB16-29X9NMDS14	BB16-29X9NMDS16	BB16-29X9NMDS60



2880	25	60	3000 K	ON/OFF	8702 lm/71 W		BB18-29W9GMOS14	BB18-29W9GMOS16	BB18-29W9GMOS60
2880	25	60	4000 K	ON/OFF	9160 lm/71 W		BB18-29X9GMOS14	BB18-29X9GMOS16	BB18-29X9GMOS60
2880	25	60	3000 K	DALI	8702 lm/71 W		BB18-29W9GMDS14	BB18-29W9GMDS16	BB18-29W9GMDS60
2880	25	60	4000 K	DALI	9160 lm/71 W		BB18-29X9GMDS14	BB18-29X9GMDS16	BB18-29X9GMDS60



2880	25	60	3000 K	ON/OFF	7372 lm/71 W		BB18-29W9NMOS14	BB18-29W9NMOS16	BB18-29W9NMOS60
2880	25	60	4000 K	ON/OFF	7760 lm/71 W		BB18-29X9NMOS14	BB18-29X9NMOS16	BB18-29X9NMOS60
2880	25	60	3000 K	DALI	7372 lm/71 W		BB18-29W9NMDS14	BB18-29W9NMDS16	BB18-29W9NMDS60
2880	25	60	4000 K	DALI	7760 lm/71 W		BB18-29X9NMDS14	BB18-29X9NMDS16	BB18-29X9NMDS60

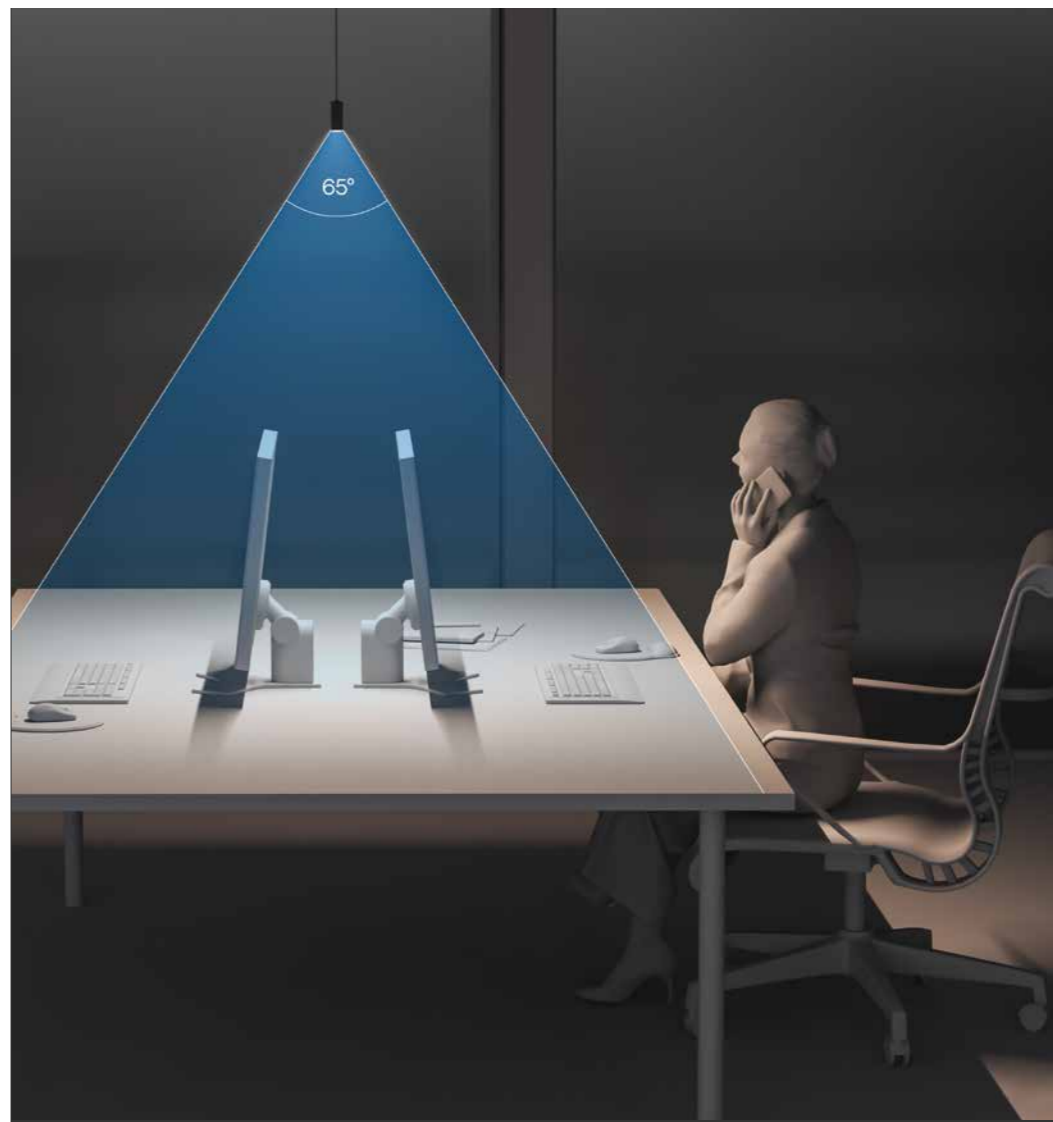

HOHER VISUELLER KOMFORT

Die Anforderungen an Arbeitsbereiche steigen kontinuierlich. Miniaturisierung und integrative Beleuchtung werden immer wichtigere Trends, da sie die Arbeitsumgebung und das Wohlbefinden der Menschen verbessern. INFINITE SLIM ist dank einer hohen Leuchtkraft und superweiten Optik in einem nur 25 mm breiten Gehäuse richtungweisend.

GREAT VISUAL COMFORT

Workspaces are becoming more demanding. Miniaturisation and integrating lighting are fundamental features that have become a trend to enhance working environments and people's well-being at work. With a high light package and super-extensive lens in a 25 mm wide body, INFINITE SLIM is a trend in itself.

AN DEN RAUM ANPASSBAR

Mit der Möglichkeit der Anbau- oder Pendelmontage ist INFINITE SLIM die perfekte Lösung zur Anpassung an das architektonische Konzept des Raumes.

ADAPTABLE TO THE SPACE

Surface mounted or suspended, INFINITE SLIM is the perfect solution to match the architectural concept of space.





STRONG 40

LINEARE ARCHITEKTURBELEUCHTUNG
AUF KLEINSTEM RAUM

- Nur 40 mm breit
- Multifunktionales Lichtsystem als Einbau-, Anbau-, Pendelleuchten möglich und als deckenbündige Einbauleuchten im Gipskanal
- Leuchteneinheiten mit Abdeckungen: Acryl satiniert (PUBLIC), Acryl Prismatic (OFFICE) oder als Wandfluter

LINEAR ARCHITECTURAL LIGHTING
IN THE SMALLEST OF SPACE

- Only 40 mm wide
- Multifunctional lighting system as recessed, surface-mounted and pendant luminaires possible and as flush-mounted recessed luminaires in gypsum element
- Luminaire units with covers: Acryl satin-coated (PUBLIC), Acryl prismatic (OFFICE) or as Wallwasher



BORA Vertriebs GmbH & Co.KG, Niederndorf | Architektur Guggenbichler + Wagenstaller, Rosenheim | Licht im Werkhaus, Isaa Sbeiti, Raubling | Foto Josefine Unterhauser, Bad Reichenhall

STRONG 40 Einbau, Anbau- und Pendelleuchten | Recessed, Surface and Pendant luminaires

LEUCHTENEINHEIT LUMINAIRE UNIT	L	CCT	Treiber Driver	Leistung Wattage	Art.-Nr. Item No.	Leistung Wattage	Art.-Nr. Item No.
PUBLIC	mm				----- LO1 -----	----- LO2 -----	
ACRYL satiniert satin-finished							



841	3000 K	ON/OFF	1400 lm/14 W	136-0841-035-003	2000 lm/19 W	136-0841-036-003	
841	4000 K	ON/OFF	1500 lm/14 W	136-0841-035-004	2100 lm/19 W	136-0841-036-004	
841	3000 K	DALI	1400 lm/14 W	136-0841-035-023	2000 lm/19 W	136-0841-036-023	
841	4000 K	DALI	1500 lm/14 W	136-0841-035-024	2100 lm/19 W	136-0841-036-024	
L 841 mm Notlicht nicht möglich Emergency light not available							
981	3000 K	ON/OFF	1650 lm/16 W	136-0981-035-024	2300 lm/22 W	136-0981-036-003	
981	4000 K	ON/OFF	1750 lm/16 W	136-0981-035-024	2400 lm/22 W	136-0981-036-004	
981	3000 K	DALI	1650 lm/16 W	136-0981-035-024	2300 lm/22 W	136-0981-036-023	
981	4000 K	DALI	1750 lm/16 W	136-0981-035-024	2400 lm/22 W	136-0981-036-024	
L 981 mm Notlicht nicht möglich Emergency light not available							
1121	3000 K	ON/OFF	1850 lm/18 W	136-1121-035-003	3600 lm/24 W	136-1121-036-003	
1121	4000 K	ON/OFF	1950 lm/18 W	136-1121-035-004	3750 lm/24 W	136-1121-036-004	
1121	3000 K	DALI	1850 lm/18 W	136-1121-035-023	3600 lm/24 W	136-1121-036-023	
1121	4000 K	DALI	1950 lm/18 W	136-1121-035-024	3750 lm/24 W	136-1121-036-024	
L 1121 mm Notlicht nicht möglich Emergency light not available							
1401	3000 K	ON/OFF	2350 lm/21 W	136-1401-035-003	3300 lm/30 W	136-1401-036-003	
1401	4000 K	ON/OFF	2450 lm/21 W	136-1401-035-004	3450 lm/30 W	136-1401-036-004	
1401	3000 K	DALI	2350 lm/21 W	136-1401-035-023	3300 lm/30 W	136-1401-036-023	
1401	4000 K	DALI	2450 lm/21 W	136-1401-035-024	3450 lm/30 W	136-1401-036-024	
1681	3000 K	ON/OFF	2800 lm/25 W	136-1681-035-003	3950 lm/36 W	136-1681-036-003	
1681	4000 K	ON/OFF	2900 lm/25 W	136-1681-035-004	4150 lm/36 W	136-1681-036-004	
1681	3000 K	DALI	2800 lm/25 W	136-1681-035-023	3950 lm/36 W	136-1681-036-023	
1681	4000 K	DALI	2900 lm/25 W	136-1681-035-024	4150 lm/36 W	136-1681-036-024	
1961	3000 K	ON/OFF	3300 lm/29 W	136-1961-035-003	4600 lm/41 W	136-1961-036-003	
1961	4000 K	ON/OFF	3450 lm/29 W	136-1961-035-004	4900 lm/41 W	136-1961-036-004	
1961	3000 K	DALI	3300 lm/29 W	136-1961-035-023	4600 lm/41 W	136-1961-036-023	
1961	4000 K	DALI	3450 lm/29 W	136-1961-035-024	4900 lm/41 W	136-1961-036-024	
2241	3000 K	ON/OFF	3750 lm/33 W	136-2241-035-003	5250 lm/47 W	136-2241-036-003	
2241	4000 K	ON/OFF	3950 lm/33 W	136-2241-035-004	5500 lm/47 W	136-2241-036-004	
2241	3000 K	DALI	3750 lm/33 W	136-2241-035-023	5250 lm/47 W	136-2241-036-023	
2241	4000 K	DALI	3950 lm/33 W	136-2241-035-024	5500 lm/47 W	136-2241-036-024	
2521	3000 K	ON/OFF	4200 lm/37 W	136-2521-035-003	5900 lm/52 W	136-2521-036-003	
2521	4000 K	ON/OFF	4450 lm/37 W	136-2521-035-004	6200 lm/52 W	136-2521-036-004	
2521	3000 K	DALI	4200 lm/37 W	136-2521-035-023	5900 lm/52 W	136-2521-036-023	
2521	4000 K	DALI	4450 lm/37 W	136-2521-035-024	6200 lm/52 W	136-2521-036-024	
90° ELEMENT	590x590	3000 K	ON/OFF	1900 lm/18 W	136-126-003	2650 lm/24 W	136-026-003
	590x590	4000 K	ON/OFF	2000 lm/18 W	136-126-004	2750 lm/24 W	136-026-004
	590x590	3000 K	DALI	1900 lm/18 W	136-126-023	2650 lm/24 W	136-026-023
	590x590	4000 K	DALI	2000 lm/18 W	136-126-024	2750 lm/24 W	136-026-024

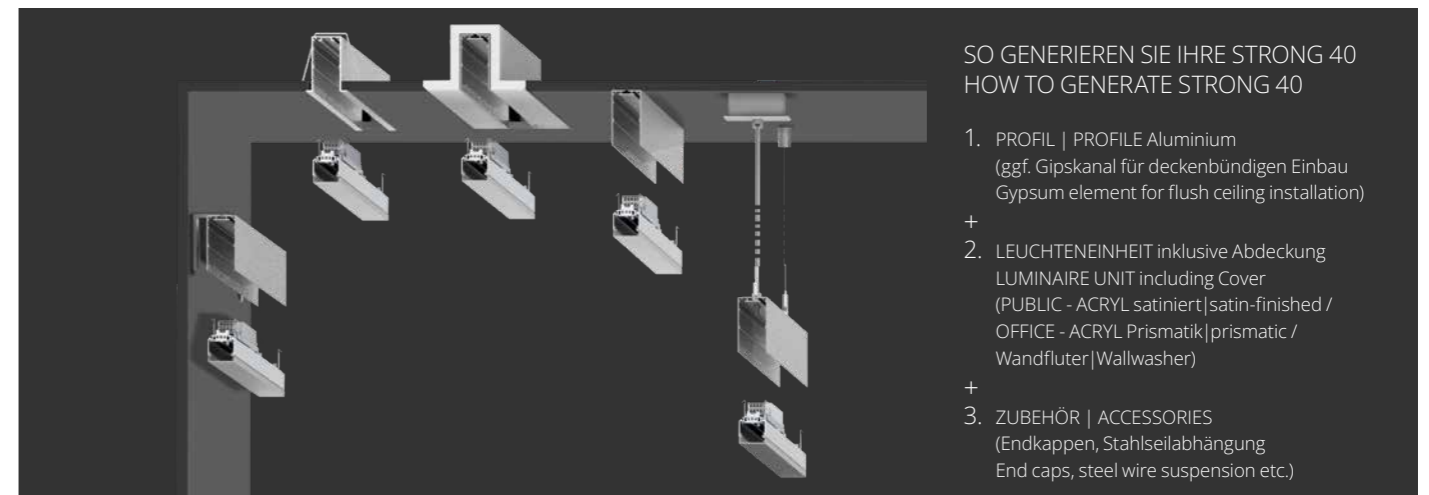

SO GENERIEREN SIE IHRE STRONG 40 HOW TO GENERATE STRONG 40



1. PROFIL | PROFILE Aluminium
(ggf. Gipskanal für deckenbündigen Einbau
Gypsum element for flush ceiling installation)
- +
2. LEUCHTENEINHEIT inklusive Abdeckung
LUMINAIRE UNIT including Cover
(PUBLIC - ACRYL satiniert | satin-finished /
OFFICE - ACRYL Prismatic | prismatic /
Wandfluter | Wallwasher)
- +
3. ZUBEHÖR | ACCESSORIES
(Endkappen, Stahlseilabhängung
End caps, steel wire suspension etc.)



Freie Universität Berlin, Lesesaal | Foto Friedemann Steinhausen, architekturphotographie, Potsdam



STRONG 40 Einbau, Anbau- und Pendelleuchten | Recessed, Surface and Pendant luminaires

ALUMINIUM PROFIL PROFILE H 75 mm	B W mm	L mm	Art.-Nr. Item No.			
ANBAU SURFACE	40	1000	136-001-100-1000	136-001-200-1000	136-001-300-1000	
PENDEL PENDANT	40	2000	136-001-100-2000	136-001-200-2000	136-001-300-2000	
EINBAU RECESSED** ** nur mit Gipskanal only with gypsum element	40	3000	136-001-100-3000	136-001-200-3000	136-001-300-3000	



Eckverbinder Angle connector	40	590x590	136-005-100	136-005-200	136-005-300
---------------------------------	----	---------	-------------	-------------	-------------



** OPTIONAL: Gipskanal für deckenbündigen Einbau | Gypsum element for flush installation

136-010-000
L 2000 mm



136-012-000
L 1000 x 1000 mm



EINBAU RECESSED	40 (56*)	1000	136-003-100-1000	136-003-200-1000	136-003-300-1000
	40 (56*)	2000	136-003-100-2000	136-003-200-2000	136-003-300-2000
	40 (56*)	3000	136-003-100-3000	136-003-200-3000	136-003-300-3000



* Rahmen|Frame

Eckverbinder Angle connector	40 (56*)	590x590	136-007-100	136-007-200	136-007-300
---------------------------------	----------	---------	-------------	-------------	-------------



* Rahmen|Frame

ZUBEHÖR ACCESSORIES	Maße Dimensions	Art.-Nr. Item No.			
-----------------------	-------------------	---------------------	---	---	---

DEMONTAGE Werkzeug für im Leuchtenprofil eingebaute Leuchteneinheiten Tool for lighting units installed in aluminium profiles		136-808-000			
---	--	-------------	--	--	--

ANBAU/PENDEL SURFACE/PENDANT Endkappen-Set End Caps	75 x 40 x 5 mm	136-801-100	136-801-200	136-801-300
--	----------------	-------------	-------------	-------------

EINBAU RECESSED Endkappen-Set End Caps	75 x 40 x 2 mm	136-805-100	136-805-200	136-805-300
---	----------------	-------------	-------------	-------------

WAND WALL Befestigungsprofil Mounting profile		136-802-100	136-802-200	136-802-300
--	--	-------------	-------------	-------------

PENDEL PENDANT Stahlseilaufhängung, kürzbar Steel cable suspension, adjustable	L 1500 mm	136-803-100	136-803-200	136-803-300
--	-----------	-------------	-------------	-------------

Kabeleinspeisung inkl. Baldachin und Stahlseil, kürzbar Cable feeder incl. canopy and steel cable, adjustable	5 x 0,75 mm ² , L 1500 mm	136-807-100	136-807-200	136-807-300
---	--------------------------------------	-------------	-------------	-------------

Blindabdeckung Aluminium Blank element aluminium	L 1000 mm	136-810-100-1000	136-810-200-1000	136-810-300-1000
	L 2000 mm	136-810-100-2000	136-810-200-2000	136-810-300-2000
	L 3000 mm	136-810-100-3000	136-810-200-3000	136-810-300-3000



STRONG 40+

LINEARE ARCHITEKTURBELEUCHTUNG
AUF KLEINSTEM RAUM

- Nur 40 mm breit
- Multifunktionales Lichtsystem als Einbau-, Anbau-, Pendelleuchten möglich und als deckenbündige Einbauleuchten im Gipskanal
- Leuchteneinheiten mit Abdeckungen: 40+ OPTIC mit dezentem indirekten Anteil

LINEAR ARCHITECTURAL LIGHTING
IN THE SMALLEST OF SPACE

- Only 40 mm wide
- Multifunctional lighting system as recessed, surface-mounted and pendant luminaires possible and as ceiling-mounted recessed luminaires in gypsum element
- Luminaire units with covers: 40+ OPTIC with discreet indirect component



STRONG 40+ Einbau-, Anbau- und Pendelleuchten | Recessed, Surface and Pendant luminaires

LEUCHTENEINHEIT LUMINAIRE UNIT 40+ OPTIC	L mm	CCT	Treiber Driver	Leistung Wattage	Art.-Nr. Item No. ----- LO1 -----	Leistung Wattage	Art.-Nr. Item No. ----- LO2 -----
--	---------	-----	-------------------	---------------------	--	---------------------	--



841	3000 K	ON/OFF	1400 lm/14 W	136-0841-065-003	2000 lm/19 W	136-0841-066-003	
841	4000 K	ON/OFF	1500 lm/14 W	136-0841-065-004	2100 lm/19 W	136-0841-066-004	
841	3000 K	DALI	1400 lm/14 W	136-0841-065-023	2000 lm/19 W	136-0841-066-023	
841	4000 K	DALI	1500 lm/14 W	136-0841-065-024	2100 lm/19 W	136-0841-066-024	
L 841 mm Notlicht nicht möglich Emergency light not available							
981	3000 K	ON/OFF	1650 lm/16 W	136-0981-065-003	2300 lm/22 W	136-0981-066-003	
981	4000 K	ON/OFF	1750 lm/16 W	136-0981-065-004	2400 lm/22 W	136-0981-066-004	
981	3000 K	DALI	1650 lm/16 W	136-0981-065-023	2300 lm/22 W	136-0981-066-023	
981	4000 K	DALI	1750 lm/16 W	136-0981-065-024	2400 lm/22 W	136-0981-066-024	
L 981 mm Notlicht nicht möglich Emergency light not available							
1121	3000 K	ON/OFF	1900 lm/18 W	136-1121-065-003	2650 lm/24 W	136-1121-066-003	
1121	4000 K	ON/OFF	2000 lm/18 W	136-1121-065-004	2750 lm/24 W	136-1121-066-004	
1121	3000 K	DALI	1900 lm/18 W	136-1121-065-023	2650 lm/24 W	136-1121-066-023	
1121	4000 K	DALI	2000 lm/18 W	136-1121-065-024	2750 lm/24 W	136-1121-066-024	
L 1121 mm Notlicht nicht möglich Emergency light not available							
1401	3000 K	ON/OFF	2350 lm/21 W	136-1401-065-003	3300 lm/30 W	136-1401-066-003	
1401	4000 K	ON/OFF	2450 lm/21 W	136-1401-065-004	3450 lm/30 W	136-1401-066-004	
1401	3000 K	DALI	2350 lm/21 W	136-1401-065-023	3300 lm/30 W	136-1401-066-023	
1401	4000 K	DALI	2450 lm/21 W	136-1401-065-024	3450 lm/30 W	136-1401-066-024	
1681	3000 K	ON/OFF	2800 lm/25 W	136-1681-065-003	3950 lm/36 W	136-1681-066-003	
1681	4000 K	ON/OFF	2900 lm/25 W	136-1681-065-004	4150 lm/36 W	136-1681-066-004	
1681	3000 K	DALI	2800 lm/25 W	136-1681-065-023	3950 lm/36 W	136-1681-066-023	
1681	4000 K	DALI	2900 lm/25 W	136-1681-065-024	4150 lm/36 W	136-1681-066-024	
1961	3000 K	ON/OFF	3300 lm/29 W	136-1961-065-003	4600 lm/41 W	136-1961-066-003	
1961	4000 K	ON/OFF	3450 lm/29 W	136-1961-065-004	4900 lm/41 W	136-1961-066-004	
1961	3000 K	DALI	3300 lm/29 W	136-1961-065-023	4600 lm/41 W	136-1961-066-023	
1961	4000 K	DALI	3450 lm/29 W	136-1961-065-024	4900 lm/41 W	136-1961-066-024	
2241	3000 K	ON/OFF	3750 lm/33 W	136-2241-065-003	5250 lm/47 W	136-2241-066-003	
2241	4000 K	ON/OFF	3950 lm/33 W	136-2241-065-004	5500 lm/47 W	136-2241-066-004	
2241	3000 K	DALI	3750 lm/33 W	136-2241-065-023	5250 lm/47 W	136-2241-066-023	
2241	4000 K	DALI	3950 lm/33 W	135-2241-065-024	5500 lm/47 W	136-2241-066-024	
2521	3000 K	ON/OFF	4200 lm/37 W	136-2521-065-003	5900 lm/52 W	136-2521-066-003	
2521	4000 K	ON/OFF	4450 lm/37 W	136-2521-065-004	6200 lm/52 W	136-2521-066-004	
2521	3000 K	DALI	4200 lm/37 W	136-2521-065-023	5900 lm/52 W	136-2521-066-023	
2521	4000 K	DALI	4450 lm/37 W	136-2521-065-024	6200 lm/52 W	136-2521-066-024	

90° ELEMENT

590x590	3000 K	ON/OFF	2500 lm/18 W	136-156-003	3450 lm/24 W	136-056-003
590x590	4000 K	ON/OFF	2600 lm/18 W	136-156-004	3650 lm/24 W	136-056-004
590x590	3000 K	DALI	2500 lm/18 W	136-156-023	3450 lm/24 W	136-056-023
590x590	4000 K	DALI	2600 lm/18 W	136-156-024	3650 lm/24 W	136-056-024

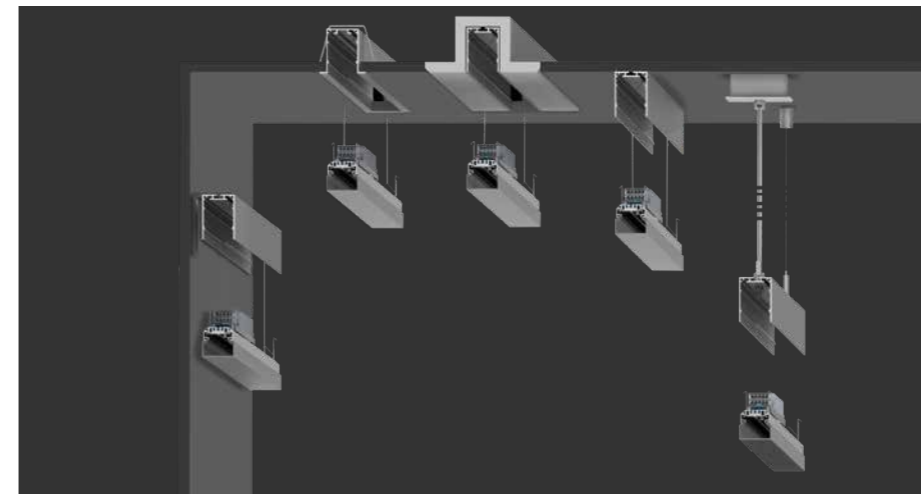

SO GENERIEREN SIE IHRE STRONG 40+ HOW TO GENERATE STRONG 40+

1. PROFIL | PROFILE Aluminium
(ggf. Gipskanal für deckenbündigen Einbau
Gypsum element for flush ceiling installation)
2. LEUCHTENEINHEIT inklusive Abdeckung
LUMINAIRE UNIT including Cover
(40+ OPTIC)
3. ZUBEHÖR | ACCESSORIES
(Endkappen, Stahlseilabhängung etc.)
End caps, steel wire suspension etc.)



STRONG 40+ Einbau, Anbau- und Pendelleuchten | Recessed, Surface and Pendant luminaires

ALUMINIUM PROFIL PROFILE	B W mm	L mm	Art.-Nr. Item No.		
----------------------------	-----------	---------	---------------------	--	--

H 55 mm					
ANBAU SURFACE	40	1000	136-002-100-1000	136-002-200-1000	136-002-300-1000
PENDEL PENDANT	40	2000	136-002-100-2000	136-002-200-2000	136-002-300-2000
EINBAU RECESSED**	40	3000	136-002-100-3000	136-002-200-3000	136-002-300-3000

** nur mit Gipskanal |
only with gypsum element

Eckverbinder Angle connector	40	590x590	136-006-100	136-006-200	136-006-300
---------------------------------	----	---------	-------------	-------------	-------------

** OPTIONAL: Gipskanal für deckenbündigen Einbau | Gypsum element for flush installation



EINBAU RECESSED	40 (56*)	1000	136-004-100-1000	136-004-200-1000	136-004-300-1000
	40 (56*)	2000	136-004-100-2000	136-004-200-2000	136-004-300-2000
	40 (56*)	3000	136-004-100-3000	136-004-200-3000	136-004-300-3000

* Rahmen | Frame

Eckverbinder Angle connector	40 (56*)	590x590	136-008-100	136-008-200	136-008-300
---------------------------------	----------	---------	-------------	-------------	-------------

* Rahmen | Frame

ZUBEHÖR ACCESSORIES	Maße Dimensions	Art.-Nr. Item No.		
-----------------------	-------------------	---------------------	--	--

DEMONTAGE Werkzeug für im Leuchtenprofil eingebaute Leuchteneinheiten Tool for lighting units installed in aluminium profiles		136-808-000		
---	--	-------------	--	--

ANBAU/PENDEL SURFACE/PENDANT Endkappen-Set End Caps	75 x 40 x 5 mm	136-801-100	136-801-200	136-801-300
--	----------------	-------------	-------------	-------------

EINBAU RECESSED Endkappen-Set End Caps	75 x 40 x 2 mm	136-806-100	136-806-200	136-806-300
---	----------------	-------------	-------------	-------------

WAND WALL Befestigungsprofil Mounting profile		136-802-100	136-802-200	136-802-300
--	--	-------------	-------------	-------------

PENDEL PENDANT Stahlseilabhängung, kürzbar Steel cable suspension, adjustable	L 1500 mm	136-803-100	136-803-200	136-803-300
---	-----------	-------------	-------------	-------------

Kabeleinpeisung inkl. Baldachin und Stahlseil, kürzbar Cable feeder incl. canopy and steel cable, adjustable	5 x 0,75 mm ² , L 1500 mm	136-807-100	136-807-200	136-807-300
--	--------------------------------------	-------------	-------------	-------------

Blindabdeckung Aluminium Blank element aluminium	L 1000 mm	136-811-100-1000	136-811-200-1000	136-811-300-1000
	L 2000 mm	136-811-100-2000	136-811-200-2000	136-811-300-2000
	L 3000 mm	136-811-100-3000	136-811-200-3000	136-811-300-3000

Variante Version STRONG 40+	RAL nach Wahl of choice	TunableWhite 2700 K - 6500 K	Notlicht Emergency 3h	CRI > 90
----------------------------------	---------------------------	---------------------------------	-------------------------	----------

Weitere Notlicht-Varianten auf Anfrage
Emergency lighting variants on request



Tageslicht- und Präsenzmelder
daylight and presence sensor

S 55 DIRECT/INDIRECT

DER ALLROUNDER
EFFIZIENT, VIELSEITIG, LANGLEBIG

- Besonders effizient, aufgrund der hohen Lichtleistung und der optimierten Lichtverteilung, gute Entblendung
- Als Einzeleuchte für Tische und einzelne Bereiche und als System mit Grund- und Erweiterungsleuchte ideal für große Räume und besondere Akzente
- WALL als konsequente Ergänzung
- Zwei Abdeckungen zur Wahl: Acryl satiniert (PUBLIC) Acryl Prismatic (OFFICE)

THE ALLROUNDER
EFFICIENT, VERSATILE, DURABLE

- Especially efficient, due to its high light output and optimal light distribution, good glare control
- As a single luminaire for tables and individual areas and as a system with start module and extension luminaires ideal for large rooms and special accents
- WALL as a logical complement
- Choice of two cover types: Acryl satin-coated (PUBLIC) Acryl prismatic (OFFICE)



S55 Pendelleuchten | Pendant luminaires

EINZELLEUCHTE | SINGLE LUMINAIRE

PUBLIC	L	B W	H	CCT	Treiber	Leistung	Art.-Nr. Item No.	CRI >80	3000K	4000K	DALI	ON OFF	IP30
ACRYL satiniert satin-finished	mm	mm		Driver	Wattage								
	1130	55	90	3000 K	ON/OFF	5000 lm/37 W	150-101-103	150-101-203	150-101-303				
	1130	55	90	4000 K	ON/OFF	5300 lm/37 W	150-101-104	150-101-204	150-101-304				
	1130	55	90	3000 K	DALI	5000 lm/37 W	150-101-123	150-101-223	150-101-323				
	1130	55	90	4000 K	DALI	5300 lm/37 W	150-101-124	150-101-224	150-101-324				
	1410	55	90	3000 K	ON/OFF	6500 lm/47 W	150-102-103	150-102-203	150-102-303				
	1410	55	90	4000 K	ON/OFF	6800 lm/47 W	150-102-104	150-102-204	150-102-304				
	1410	55	90	3000 K	DALI	6500 lm/47 W	150-102-123	150-102-223	150-102-323				
	1410	55	90	4000 K	DALI	6800 lm/47 W	150-102-124	150-102-224	150-102-324				

OFFICE ACRYL Prismatic | prismatic

	L	B W	H	CCT	Treiber	Leistung	Art.-Nr. Item No.	UGR <19	CRI >80	3000K	4000K	DALI	ON OFF	IP30
	1130	55	90	3000 K	ON/OFF	4700 lm/37 W	150-103-103	150-103-203	150-103-303					
	1130	55	90	4000 K	ON/OFF	4900 lm/37 W	150-103-104	150-103-204	150-103-304					
	1130	55	90	3000 K	DALI	4700 lm/37 W	150-103-123	150-103-223	150-103-323					
	1130	55	90	4000 K	DALI	4900 lm/37 W	150-103-124	150-103-224	150-103-324					
	1410	55	90	3000 K	ON/OFF	6050 lm/47 W	150-104-103	150-104-203	150-104-303					
	1410	55	90	4000 K	ON/OFF	6350 lm/47 W	150-104-104	150-104-204	150-104-304					
	1410	55	90	3000 K	DALI	6050 lm/47 W	150-104-123	150-104-223	150-104-323					
	1410	55	90	4000 K	DALI	6350 lm/47 W	150-104-124	150-104-224	150-104-324					

Variante | Version
S55

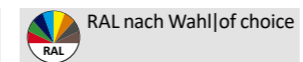

RAL nach Wahl | of choice

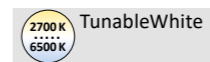

TunableWhite

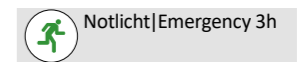

Notlicht | Emergency 3h



CRI > 90

Weitere Notlicht-Varianten auf Anfrage
Emergency lighting variants on request



EINFACHER ANSCHLUSS | SIMPLE CONNECTION
Das Leuchtenkabel ist bei der S55 schon an der Leuchteneinheit befestigt, damit gelingt der Anschluss schnell und sicher.
The cable is already fastened to the luminaire. This enables fast and safe power connection.



EINFACHE MONTAGE | SIMPLE INSTALLATION
Die Aufhängung wird werkzeuglos mit Clips am Leuchtenkörper befestigt, diese können stufenlos verschoben werden.
The suspension is fastened with clips to the body of the luminaire, without using tools. The clips can be pushed steplessly into position in line with the suspension points on the ceiling.



EINFACHE ERWEITERUNG | SIMPLE EXTENSION
Die Leuchteneinheiten werden über ein einfaches Stecksystem miteinander verbunden, um eine Systembeleuchtung zu schaffen.
The lighting units are connected with each other by a simple plug-in solution to create a complete lighting system.



EINFACHE BESTELLUNG | SIMPLE ORDER PROCESS
Alles inklusive:
Bestellt werden abgeschlossene Module. Zubehör muss nicht extra gewählt oder bestellt werden.
Everything is included:
Complete modules are ordered. Accessories do not have to be selected or ordered separately.



STRONG 55 DIRECT



DAS LINEARE LICHTBAND

- Breite 55 mm
- Direkte Lichtverteilung
- Multifunktionales Lichtsystem als Einbau-, Anbau-, Pendelleuchten möglich und als deckenbündige Einbauleuchten im Gipskanal
- Zwei Abdeckungen: Acryl satiniert (PUBLIC) Acryl Prismatik (OFFICE)

THE CONTINUOUS LUMINAIRE

- Width 55 mm
- Direct light distribution
- Multifunctional lighting system available as recessed, surface-mounted and pendant luminaires and as flush-mounted recessed luminaires in gypsum element
- Two cover: Acryl satin-coated (PUBLIC) Acryl prismatic (OFFICE)



STRONG 55 Einbau, Anbau- und Pendelleuchten | Recessed, Surface and Pendant luminaires

LEUCHTENEINHEIT | LUMINAIRE UNIT

für Abdeckung for cover	L	CCT	Treiber	Leistung	Art.-Nr. Item No.	Leistung	Art.-Nr. Item No.
PUBLIC	mm		Driver	Wattage	LO1	Wattage	LO2
ACRYL satiniert satin-finished							



840	3000 K	ON/OFF	1400 lm/15 W	152-0840-035-003	2700 lm/28 W	152-0840-036-003	
840	4000 K	ON/OFF	1450 lm/15 W	152-0840-035-004	2800 lm/28 W	152-0840-036-004	
840	3000 K	DALI	1400 lm/15 W	152-0840-035-023	2700 lm/28 W	152-0840-036-023	
840	4000 K	DALI	1450 lm/15 W	152-0840-035-024	2800 lm/28 W	152-0840-036-024	
L 840 mm Notlicht nicht möglich Emergency light not available							
980	3000 K	ON/OFF	1650 lm/17 W	152-0980-035-003	3150 lm/32 W	152-0980-036-003	
980	4000 K	ON/OFF	1700 lm/17 W	152-0980-035-004	3300 lm/32 W	152-0980-036-004	
980	3000 K	DALI	1650 lm/17 W	152-0980-035-024	3150 lm/32 W	152-0980-036-023	
980	4000 K	DALI	1700 lm/17 W	152-0980-035-024	3300 lm/32 W	152-0980-036-024	
L 980 mm Notlicht nicht möglich Emergency light not available							
1120	3000 K	ON/OFF	1850 lm/19 W	152-1120-035-003	3600 lm/36 W	152-1120-036-003	
1120	4000 K	ON/OFF	1950 lm/19 W	152-1120-035-004	3750 lm/36 W	152-1120-036-004	
1120	3000 K	DALI	1850 lm/19 W	152-1120-035-023	3600 lm/36 W	152-1120-036-023	
1120	4000 K	DALI	1950 lm/19 W	152-1120-035-024	3750 lm/36 W	152-1120-036-024	
1400	3000 K	ON/OFF	2350 lm/23 W	152-1400-035-003	4500 lm/44 W	152-1400-036-003	
1400	4000 K	ON/OFF	2400 lm/23 W	152-1400-035-004	4700 lm/44 W	152-1400-036-004	
1400	3000 K	DALI	2350 lm/23 W	152-1400-035-023	4500 lm/44 W	152-1400-036-023	
1400	4000 K	DALI	2400 lm/23 W	152-1400-035-024	4700 lm/44 W	152-1400-036-024	
1680	3000 K	ON/OFF	2800 lm/27 W	152-1680-035-003	5350 lm/52 W	152-1680-036-003	
1680	4000 K	ON/OFF	2900 lm/27 W	152-1680-035-004	5600 lm/52 W	152-1680-036-004	
1680	3000 K	DALI	2800 lm/27 W	152-1680-035-023	5350 lm/52 W	152-1680-036-023	
1680	4000 K	DALI	2900 lm/27 W	152-1680-035-024	5600 lm/52 W	152-1680-036-024	
1960	3000 K	ON/OFF	3400 lm/29 W	152-1960-035-003	6450 lm/58 W	152-1960-036-003	
1960	4000 K	ON/OFF	3600 lm/29 W	152-1960-035-004	6800 lm/58 W	152-1960-036-004	
1960	3000 K	DALI	3400 lm/29 W	152-1960-035-023	6450 lm/58 W	152-1960-036-023	
1960	4000 K	DALI	3600 lm/29 W	152-1960-035-024	6800 lm/58 W	152-1960-036-024	
2240	3000 K	ON/OFF	3700 lm/35 W	152-2240-035-003	7150 lm/68 W	152-2240-036-003	
2240	4000 K	ON/OFF	3850 lm/35 W	152-2240-035-004	7500 lm/68 W	152-2240-036-004	
2240	3000 K	DALI	3700 lm/35 W	152-2240-035-023	7150 lm/68 W	152-2240-036-023	
2240	4000 K	DALI	3850 lm/35 W	152-2240-035-024	7500 lm/68 W	152-2240-036-024	
2520	3000 K	ON/OFF	4200 lm/39 W	152-2520-035-003	8050 lm/76 W	152-2520-036-003	
2520	4000 K	ON/OFF	4350 lm/39 W	152-2520-035-004	8400 lm/76 W	152-2520-036-004	
2520	3000 K	DALI	4200 lm/39 W	152-2520-035-023	8050 lm/76 W	152-2520-036-023	
2520	4000 K	DALI	4350 lm/39 W	152-2520-035-024	8400 lm/76 W	152-2520-036-024	

90° ELEMENT

596x596	3000 K	ON/OFF	1850 lm/19 W	152-0600-335-003	3600 lm/34 W	152-0600-336-003
596x596	4000 K	ON/OFF	1950 lm/19 W	152-0600-335-004	3750 lm/34 W	152-0600-336-004
596x596	3000 K	DALI	1850 lm/19 W	152-0600-335-023	3600 lm/34 W	152-0600-336-023
596x596	4000 K	DALI	1950 lm/19 W	152-0600-335-024	3750 lm/34 W	152-0600-336-024

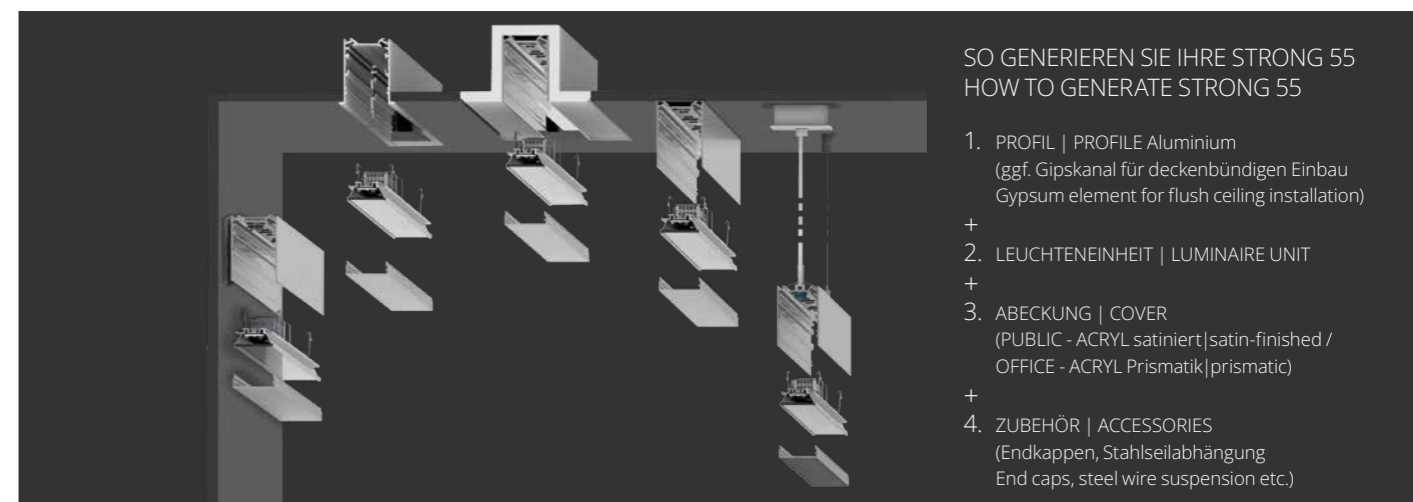

SO GENERIEREN SIE IHRE STRONG 55 HOW TO GENERATE STRONG 55

1. PROFIL | PROFILE Aluminium (ggf. Gipskanal für deckenbündigen Einbau Gypsum element for flush ceiling installation)
2. LEUCHTENEINHEIT | LUMINAIRE UNIT
3. ABECKUNG | COVER (PUBLIC - ACRYL satiniert | satin-finished / OFFICE - ACRYL Prismatik | prismatic)
4. ZUBEHÖR | ACCESSORIES (Endkappen, Stahlseilabhängung End caps, steel wire suspension etc.)

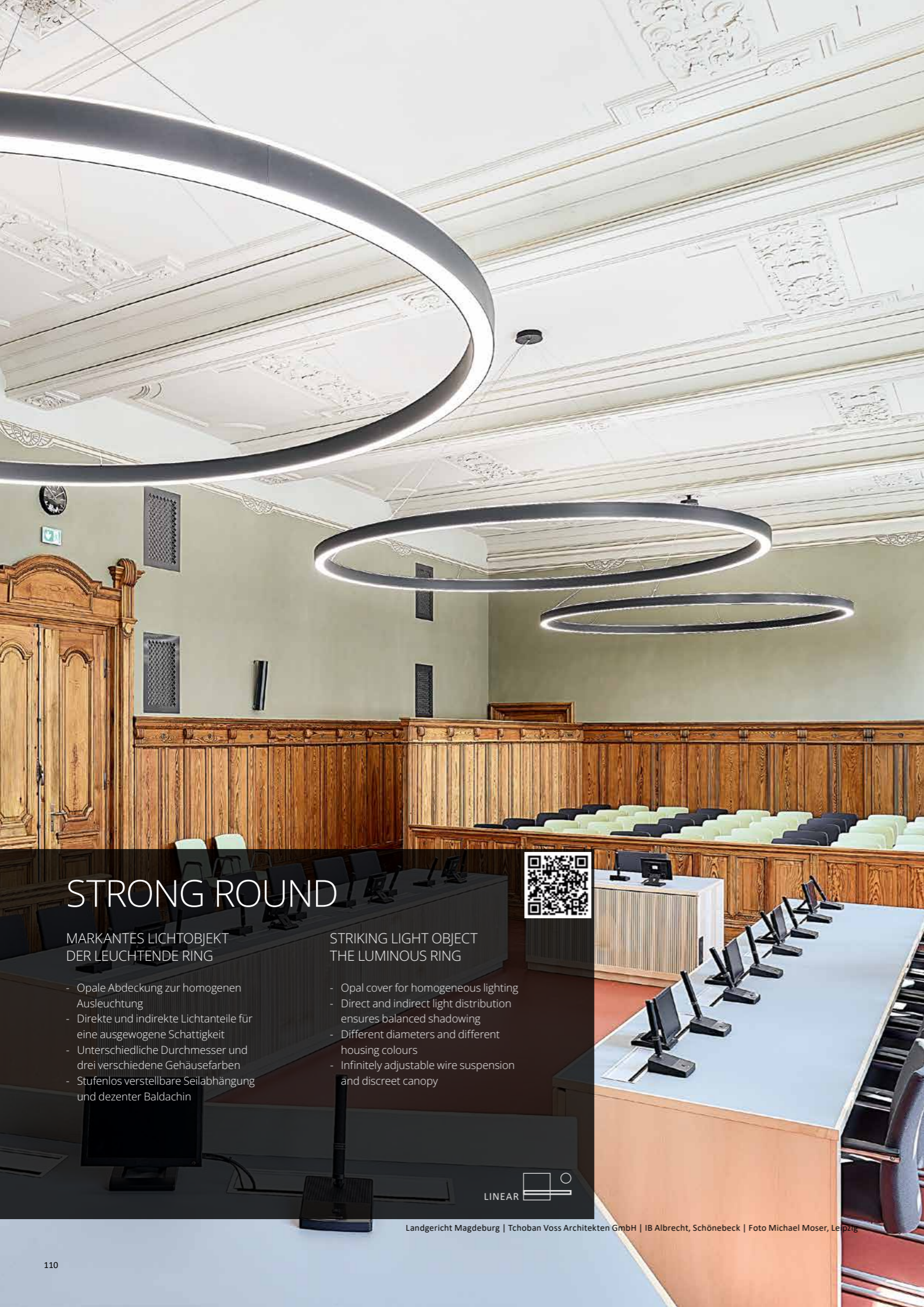

STRONG ROUND

MARKANTES LICHTOBJEKT
DER LEUCHTENDE RING

- Opale Abdeckung zur homogenen Ausleuchtung
- Direkte und indirekte Lichtanteile für eine ausgewogene Schattigkeit
- Unterschiedliche Durchmesser und drei verschiedene Gehäusefarben
- Stufenlos verstellbare Seilabhangung und dezenter Baldachin

STRIKING LIGHT OBJECT
THE LUMINOUS RING

- Opal cover for homogeneous lighting
- Direct and indirect light distribution ensures balanced shadowing
- Different diameters and different housing colours
- Infinitely adjustable wire suspension and discreet canopy

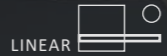

Landgericht Magdeburg | Tchoban Voss Architekten GmbH | IB Albrecht, Schönebeck | Foto Michael Moser, Leipzig

STRONG ROUND Pendelleuchten | Pendant luminaires

ACRYL opal		D	B W	H	CCT	Treiber Driver	Leistung Wattage	Art.-Nr. Item No.		CRI > 80	3000 K	4000 K	DALI	IP20
		mm	mm	mm				○	●					
	603	60	65	3000 K	DALI	4350 lm/38 W	164-001-123	164-001-223	164-001-323					
	603	60	65	4000 K	DALI	4560 lm/38 W	164-001-124	164-001-224	164-001-324					
	800	60	65	3000 K	DALI	5810 lm/51 W	164-002-123	164-002-223	164-002-323					
	800	60	65	4000 K	DALI	6090 lm/51 W	164-002-124	164-002-224	164-002-324					
	1140	60	65	3000 K	DALI	9290 lm/86 W	164-003-123	164-003-223	164-003-323					
	1140	60	65	4000 K	DALI	9740 lm/86 W	164-003-124	164-003-224	164-003-324					
	1515	60	65	3000 K	DALI	11620 lm/103 W	164-004-123	164-004-223	164-004-323					
	1515	60	65	4000 K	DALI	12180 lm/103 W	164-004-124	164-004-224	164-004-324					
	600	100	87	3000 K	DALI	4100 lm/38 W	165-001-123	165-001-223	165-001-323					
	600	100	87	4000 K	DALI	4300 lm/38 W	165-001-124	165-001-224	165-001-324					
	850	100	87	3000 K	DALI	6150 lm/58 W	165-002-123	165-002-223	165-002-323					
	850	100	87	4000 K	DALI	6460 lm/58 W	165-002-124	165-002-224	165-002-324					
	1200	100	87	3000 K	DALI	8200 lm/77 W	165-003-123	165-003-223	165-003-323					
	1200	100	87	4000 K	DALI	8610 lm/77 W	165-003-124	165-003-224	165-003-324					
	1500	100	87	3000 K	DALI	10360 lm/98 W	165-004-123	165-004-223	165-004-323					
	1500	100	87	4000 K	DALI	10880 lm/98 W	165-004-124	165-004-224	165-004-324					

Variante | Version
STRONG ROUND

RAL nach Wahl | of choice



PENDELVARIANTEN | PENDANT VARIANTS

Pendelvarianten in Abhängigkeit von dem Durchmesser der Leuchten.
Pendant variants depending on the diameter of the lights.

Profil Profile	Durchmesser Diameter
60 mm	603 und 800 mm
100 mm	600 und 850 mm

Profil Profile	Durchmesser Diameter
60 mm	1140 und 1515 mm
100 mm	1200 und 1500 mm

LICHT & NATUR

Islandmoos - ein konserviertes Naturmaterial, langlebige, lichtechte Farbe
Als Akustikelement reduziert es unangenehme Geräusche und verbessert zusätzlich das Raumklima, indem es Luftfeuchtigkeit speichert und reguliert (Moosplatte austauschbar).

LIGHT & NATURE

Iceland moss - a preserved natural material, long-lasting, lightfast colour
As an acoustic element, it reduces unpleasant noises and also improves the room climate by storing and regulating humidity (moss panel can be replaced).





STRADA

ZEITLOSES DESIGN
STARK, EFFIZIENT, LANGLEBIG

- Ausstrahlwinkel 270°
- Absolut gleichmäßige Lichtverteilung
- Als Einzelleuchte für Tische und einzelne Bereiche und als System mit Grund- und Erweiterungsleuchte ideal für große Räume und besondere Akzente
- SYSTEM Verbindung von Leuchten über einfaches Stecksystem
- Werkzeuglose Aufhängung mit Clips, Aufhängepunkte stufenlos verschiebbar

TIMELESS DESIGN
STRONG, EFFICIENT, DURABLE

- Beam angle 270°
- Absolutely uniform light distribution
- As a single luminaire for tables and individual areas and as a system with start module and extension luminaires ideal for large rooms and special accents
- SYSTEM luminaires connected by easy plug-in solution
- Toolless suspension with clips, suspension points infinitely displaceable

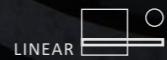

STRADA Pendelleuchten | Pendant luminaires

ACRYL satiniert | satin-finished

	L mm	D mm	CCT	Treiber Driver	Leistung Wattage	Art.-Nr. Item No.	<input type="radio"/> <input checked="" type="radio"/>
EINZELLEUCHE SINGLE LUMINAIRE	1130	75	3000 K	ON/OFF	2400 lm/15 W	155-001-103	<input type="radio"/> <input checked="" type="radio"/>
	1130	75	4000 K	ON/OFF	2550 lm/15 W	155-001-104	<input type="radio"/> <input checked="" type="radio"/>
	1130	75	3000 K	DALI	2400 lm/15 W	155-001-123	<input type="radio"/> <input checked="" type="radio"/>
	1130	75	4000 K	DALI	2550 lm/15 W	155-001-124	<input type="radio"/> <input checked="" type="radio"/>
	1410	75	3000 K	ON/OFF	3000 lm/19 W	155-002-103	<input type="radio"/> <input checked="" type="radio"/>
	1410	75	4000 K	ON/OFF	3150 lm/19 W	155-002-104	<input type="radio"/> <input checked="" type="radio"/>
	1410	75	3000 K	DALI	3000 lm/19 W	155-002-123	<input type="radio"/> <input checked="" type="radio"/>
	1410	75	4000 K	DALI	3150 lm/19 W	155-002-124	<input type="radio"/> <input checked="" type="radio"/>

Variante | Version
STRADA

RAL nach Wahl | of choice

2700 K
6500 K TunableWhite

Notlicht | Emergency 3h

Weitere Notlicht-Varianten auf Anfrage
Emergency lighting variants on request



EINFACHER ANSCHLUSS | SIMPLE CONNECTION
Das Leuchtenkabel ist bei der STRADA schon an der Leuchteneinheit befestigt, damit gelingt der Anschluss schnell und sicher.
The cable is already delivered fastened to the luminaire. This enables fast and safe power connection.



EINFACHE MONTAGE | SIMPLE INSTALLATION
Die Aufhängung wird werkzeuglos mit Clips am Leuchtenkörper befestigt, diese können stufenlos verschoben werden.
The suspension is fastened with clips to the body of the luminaire, without using tools. The clips can be pushed steplessly into position in line with the suspension points on the ceiling.

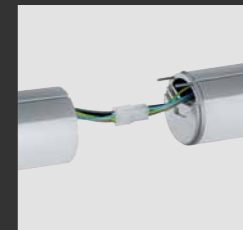

EINFACHE ERWEITERUNG | SIMPLE EXTENSION
Die Leuchteneinheiten werden über ein einfaches Stecksystem miteinander verbunden, um eine Systembeleuchtung zu schaffen.
The lighting units are connected with each other by a simple plug-in solution to create a complete lighting system.



EINFACHE BESTELLUNG | SIMPLE ORDER PROCESS
Alles inklusive:
Bestellt werden abgeschlossene Module. Zubehör muss nicht extra gewählt oder bestellt werden.
Everything is included:
Complete modules are ordered. Accessories do not have to be selected or ordered separately.



STRADA Pendelleuchten | Pendant luminaires

ACRYL satiniert | satin-finished

	L mm	D mm	CCT	Treiber Driver	Leistung Wattage	Art.-Nr. Item No.	
GRUNDLEUCHTE BASIC LUMINAIRE	1125	75	3000 K	ON/OFF	2400 lm/15 W	155-1125-135-103	155-1125-135-203
	1125	75	4000 K	ON/OFF	2550 lm/15 W	155-1125-135-104	155-1125-135-204
	1125	75	3000 K	DALI	2400 lm/15 W	155-1125-135-123	155-1125-135-223
	1125	75	4000 K	DALI	2550 lm/15 W	155-1125-135-124	155-1125-135-224
	1405	75	3000 K	ON/OFF	3000 lm/19 W	155-1405-135-103	155-1405-135-203
	1405	75	4000 K	ON/OFF	3150 lm/19 W	155-1405-135-104	155-1405-135-204
	1405	75	3000 K	DALI	3000 lm/19 W	155-1405-135-123	155-1405-135-223
	1405	75	4000 K	DALI	3150 lm/19 W	155-1405-135-124	155-1405-135-224
	1685	75	3000 K	ON/OFF	3600 lm/22 W	155-1685-135-103	155-1685-135-203
	1685	75	4000 K	ON/OFF	3800 lm/22 W	155-1685-135-104	155-1685-135-204
	1685	75	3000 K	DALI	3600 lm/22 W	155-1685-135-123	155-1685-135-223
	1685	75	4000 K	DALI	3800 lm/22 W	155-1685-135-124	155-1685-135-224
	2245	75	3000 K	ON/OFF	4800 lm/28 W	155-2245-135-103	155-2245-135-203
	2245	75	4000 K	ON/OFF	5050 lm/28 W	155-2245-135-104	155-2245-135-204
	2245	75	3000 K	DALI	4800 lm/28 W	155-2245-135-123	155-2245-135-223
	2245	75	4000 K	DALI	5050 lm/28 W	155-2245-135-124	155-2245-135-224
	2525	75	3000 K	ON/OFF	5400 lm/31 W	155-2525-135-103	155-2525-135-203
	2525	75	4000 K	ON/OFF	5700 lm/31 W	155-2525-135-104	155-2525-135-204
	2525	75	3000 K	DALI	5400 lm/31 W	155-2525-135-123	155-2525-135-223
	2525	75	4000 K	DALI	5700 lm/31 W	155-2525-135-124	155-2525-135-224
ERWEITERUNG EXTENSION	1125	75	3000 K	ON/OFF	2400 lm/15 W	155-1125-235-103	155-1125-235-203
	1125	75	4000 K	ON/OFF	2550 lm/15 W	155-1125-235-104	155-1125-235-204
	1125	75	3000 K	DALI	2400 lm/15 W	155-1125-235-123	155-1125-235-223
	1125	75	4000 K	DALI	2550 lm/15 W	155-1125-235-124	155-1125-235-224
	1405	75	3000 K	ON/OFF	3000 lm/19 W	155-1405-235-103	155-1405-235-203
	1405	75	4000 K	ON/OFF	3150 lm/19 W	155-1405-235-104	155-1405-235-204
	1405	75	3000 K	DALI	3000 lm/19 W	155-1405-235-123	155-1405-235-223
	1405	75	4000 K	DALI	3150 lm/19 W	155-1405-235-124	155-1405-235-224
	1685	75	3000 K	ON/OFF	3600 lm/22 W	155-1685-235-103	155-1685-235-203
	1685	75	4000 K	ON/OFF	3800 lm/22 W	155-1685-235-104	155-1685-235-204
	1685	75	3000 K	DALI	3600 lm/22 W	155-1685-235-123	155-1685-235-223
	1685	75	4000 K	DALI	3800 lm/22 W	155-1685-235-124	155-1685-235-224
	2245	75	3000 K	ON/OFF	4800 lm/28 W	155-2245-235-103	155-2245-235-203
	2245	75	4000 K	ON/OFF	5050 lm/28 W	155-2245-235-104	155-2245-235-204
	2245	75	3000 K	DALI	4800 lm/28 W	155-2245-235-123	155-2245-235-223
	2245	75	4000 K	DALI	5050 lm/28 W	155-2245-235-124	155-2245-235-224
	2525	75	3000 K	ON/OFF	5400 lm/31 W	155-2525-235-103	155-2525-235-203
	2525	75	4000 K	ON/OFF	5700 lm/31 W	155-2525-235-104	155-2525-235-204
	2525	75	3000 K	DALI	5400 lm/31 W	155-2525-235-123	155-2525-235-223
	2525	75	4000 K	DALI	5700 lm/31 W	155-2525-235-124	155-2525-235-224

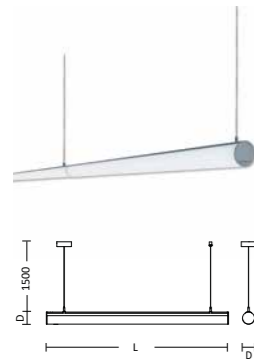

I
n
d
e
x



GREAT

SCHWEBENDES LICHTOBJEKT
AUF DAS WESENTLICHE REDUZIERT

- Nur 36 mm hoher Ring aus gepulvertem Aluminium
- Dünne umlaufende LED-Lichteinheit
- Ausstrahlung ohne sichtbare Unterbrechungen

FLOATING LIGHT OBJECT
REDUCED TO THE ESSENTIAL

- Only 36 mm thin made of powder-coated aluminium
- Thin peripheral LED lighting unit
- Distribution without visible interruptions



GREAT Pendelleuchten | Pendant luminaires

ACRYL satiniert | satin-finished

D mm	H mm	CCT	Treiber Driver	Leistung Wattage	Art.-Nr. Item No.
560	36	3000 K	DALI	3420 lm/48 W	161-001-123
560	36	4000 K	DALI	3420 lm/48 W	161-001-124
810	36	3000 K	DALI	5140 lm/72 W	161-002-123
810	36	4000 K	DALI	5140 lm/72 W	161-002-124
1130	36	3000 K	DALI	7280 lm/102 W	161-003-123
1130	36	4000 K	DALI	7280 lm/102 W	161-003-124
1580	36	3000 K	DALI	10280 lm/144 W	161-004-123
1580	36	4000 K	DALI	10280 lm/144 W	161-004-124

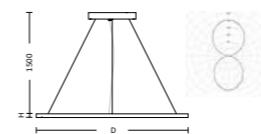

TAILOR MADE

Die Kombination aus GREAT und PEARL ergibt eine galaktisch gute TAILOR MADE-Lichtlösung. Wir sind immer offen für Ihre Ideen und arbeiten gerne mit Ihnen zusammen, um kreative, auch ungewöhnliche Lichtlösungen zu schaffen, aber natürlich immer mit dem nötigen Maß an Professionalität und Funktionalität.

The combination of GREAT and PEARL results in a galactically good TAILOR MADE lighting solution. We are always open to your ideas and are happy to work with you to create lighting solutions that are creative, even unusual, but of course always with the necessary degree of professionalism and functionality.

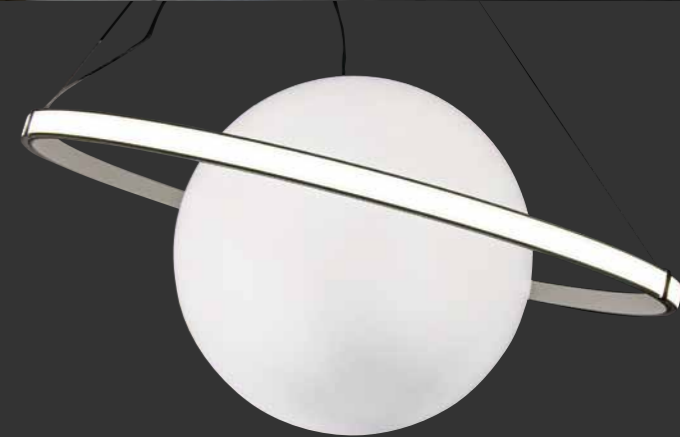

I
n
d
e
x



G-CONCEPT

G STEHT FÜR GIPS
KREATIVE DECKEN- UND WAND-
GESTALTUNG

- Die Komplettlösung Leuchten und Gipselemente aus einer Hand.
- Zeit- und kostensparende Komplettlösung für den Bauherren
 - Einfacher, schneller und sauberer Einbau in Decken und Wände
 - Hohe Passgenauigkeit der Systemkomponenten
 - Softe Einlassungen in Gipskartondecken/-wände

G STANDS FOR GYPSUM
CREATIVE CEILING AND WALL
DESIGN

- The complete solution for luminaires and gypsum elements from a single source
- Time and cost-saving complete solution for the building owner
 - Simple, quick and clean installation in ceilings and walls
 - High fitting accuracy of the system components
 - Soft insertion into plasterboard ceilings/walls

Officina Vidre Negre | Damilano studio architects | Foto Andrea Martiradonna

SYSTEM G-CONCEPT

Qualität aus einer Hand: Das G-Concept verbindet technisch hochwertige Lichtlösungen mit vorgefertigten Gipselementen für den Trockenbau: Einbaukanäle, Decken- oder Wandeinbauleuchten und Lichtvoutensysteme decken sämtliche Bedarfe von Planern, Trockenbauern und Installateuren ab.

Quality from a single source: The G-Concept combines high-quality technical lighting solutions with prefabricated plaster elements for drywall construction: recessed trunking, recessed ceiling or wall luminaires and cove lighting systems cover all the needs of planners, drywall builders and installers.



Sämtliche Kanäle und Module sind aus Gips und exakt auf die Lichtlösungen abgestimmt. Mit diesem Gesamtkonzept lassen sich Objekte jederzeit bedarfsgerecht und hocheffizient ausleuchten. All channels and modules are made of gypsum and exactly match the lighting systems. This complete solution allows projects to be illuminated as needed: variably and with high efficiency at the same time.



Einfach, schnell und sauber setzen Trockenbauer die vorgefertigten Gipselemente in die Decken-Unterkonstruktion oder das Wand-Ständerwerk ein. Die Gefahr von Fugen oder Kantenrissen entsteht praktisch nicht mehr. Nachdem die Fugen verspachtelt und die Wände bzw. Decken gestrichen sind, lassen sich die passgenauen Leuchten sehr einfach montieren und elektrifizieren.

Contractors simply install the prefabricated gypsum elements in the ceiling substructure or wall posts. The risk of cracks appearing in joints or edges is virtually eliminated. After joints have been plastered and the walls and/or ceilings have been painted, the luminaires can be easily installed.

TZ-200 Voutensystem für die kreative Deckengestaltung. Aus Geraden und Viertelbögen mit unterschiedlichen Radien lassen sich Kreise, Ovale oder andere kreative Formen gestalten. Sprechen Sie uns an für Ihre Lichtgestalt ohne Ecken und Kanten.

TZ-200 cove system for creative ceiling design. Circles, ovals and other creative shapes can be created from straight lines and quarter arcs with different radii. Contact us for your light shape without corners and edges.

Gipselement Gypsum element	D mm	L mm	Art.-Nr./Item No.
GERADE	-	2000	51002.00
VOLLKREIS	1000	-	51126.00
	1600	-	51127.00
	2400	-	51128.00



LED-Einheiten werden mit der rückwandigen Klebefolie des Stripes in die dafür vorgesehene Führung des Lichtvouten-Oberteils geklebt. Entsprechende Netzteile und Steuergeräte werden in das Unterteil der Lichtvoute gelegt.

Using the adhesive film of the stripes, the LED units are glued into the prepared track in the cove element. Corresponding power supply units and control units are placed in the lower part of the cove element.



TAILOR MADE

UNSER VERSTÄNDNIS VON TAILOR MADE

Wir bieten Ihnen auf Sie abgestimmte Lichtlösungen. Maßgeschneidert für Ihr Projekt. Sie gestalten und wir liefern Ihnen die Lichtwerkzeuge, die Sie für Ihre Arbeit benötigen. Flexibilität wird bei uns großgeschrieben, wir wollen den lebendigen Dialog mit Ihnen.

Ihr Problem ist unsere Herausforderung.

Sprechen Sie uns an, wir finden eine Produktvariante, die zu Ihren Wünschen passt.

OUR UNDERSTANDING OF TAILOR MADE

We offer tailored lighting solutions for you, customised to your project. You design and we supply you with the lighting tools you need for your work. Flexibility is very important to us, we want a lively dialogue with you.

Your problem is our challenge.

Talk to us, we will find a product variant that suits your needs.



PEARL
integriertes Downlight
integrated Downlight



PLANAR - Deckenbündiges Montagesystem | Flush mounting system



CLEAR 4.0
Sinnvolle Wegeföhrung - ganz selbstverständlich auch in Brailleschrift
Meaningful routing - also in Braille



PARO
Doppelleuchte | Double luminaire



Sophie-Barat-Schule, Hamburg

SIRO Anbau- und Pendelleuchten mit passivierter Oberfläche und speziell angepasste STRONG 40 | SIRO surface-mounted and pendant luminaires with passivated surface and specially adapted STRONG 40

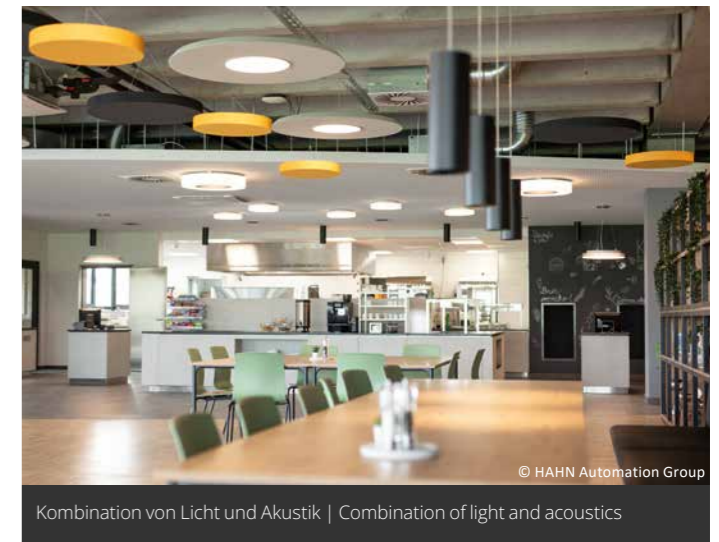

© HAHN Automation Group

Kombination von Licht und Akustik | Combination of light and acoustics

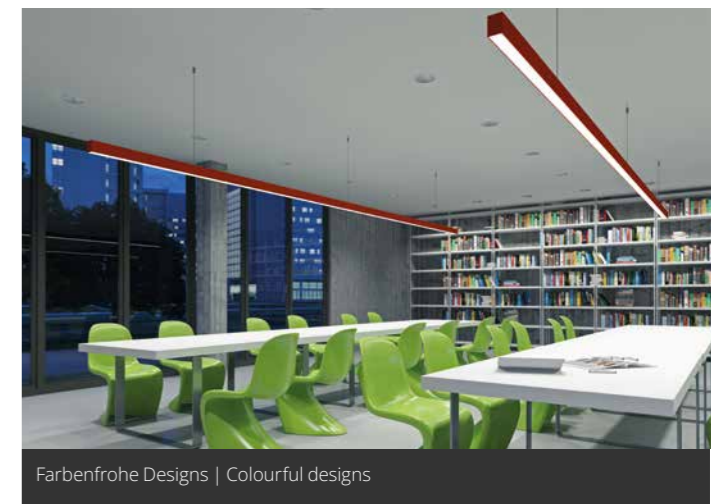

Farbenfrohe Designs | Colourful designs

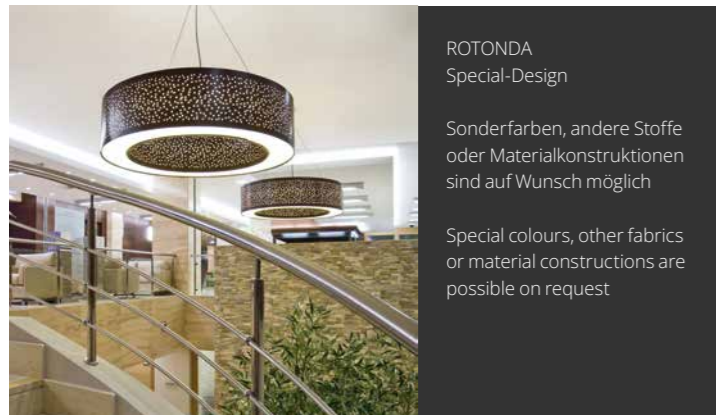

ROTONDA
Special-Design

Sonderfarben, andere Stoffe oder Materialkonstruktionen sind auf Wunsch möglich

Special colours, other fabrics or material constructions are possible on request



VOLUMA mit Akkustikelement | with acoustic element



Museumsinsel Underground, Berlin | Foto: Antonio Reetz-Graudenz, Berlin

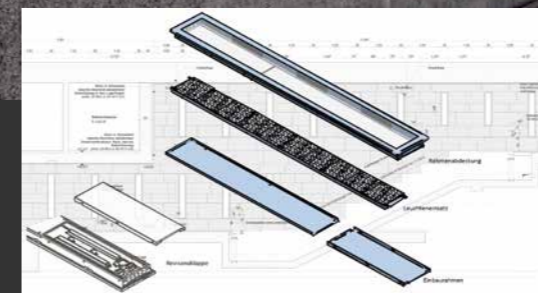

Fugenlos eingelassene Beleuchtung in Säulen aus Natursteinverkleidung (Granit)
Spezielles Befestigungssystem, Leuchteneinsatz herausziehbar, Abdeckung ausschwenkbar, Revisionsöffnung durch Leuchtgehäuse, Gesamtschutzart IP54

Seamlessly recessed luminaires in pillars made of natural stone cladding (granite)
Special fastening system, pull-out luminaire insert, swivelling cover, inspection opening through luminaire housing, overall protection rating IP54

MORE TO COME

KONFIGURATOREN | CONFIGURATORS

Noch nie war das Planen so einfach!
Unsere Konfiguratoren sind selbsterklärend und führen Sie Schritt für Schritt durch Ihr Projekt. Selbstverständlich können Sie auf einer Plattform unterschiedlichste Produktfamilien zusammenstellen - ohne zwischen den Konfiguratoren hin- und herzuspringen.

Planning has never been so easy!
Our configurators are intuitive and guide you through your project step by step. You can compile various product families on a single platform - without the need to switch between different configurators.

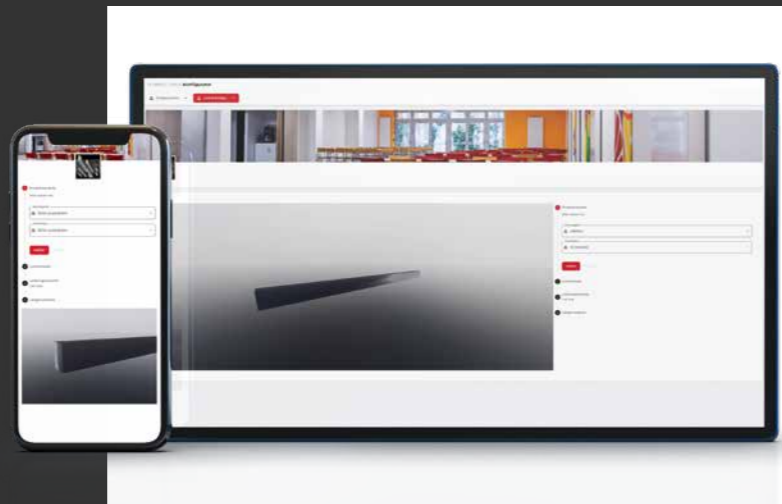

STRONG CONNECT

MULTIFUNKTIONALES LINEARES LICHTSYSTEM

MULTIFUNCTIONAL LINEAR LIGHTING SYSTEM

Zeitloses Design kombiniert mit höchster Modularität und einfacher Handhabung
Gleichzeitige mechanische und elektrische Verbindung der Tragschienen mit einem „Click“

Timeless design: Combines aesthetics with practicality
Simultaneous mechanical and electrical connection with a simple “click”

ACOUSTIC

PROFESSIONELLES BELEUCHTUNGSSYSTEM MIT EXTREM GROSSER SCHALLWIRKSAMER MASSE

„Stress Reversing“-Technologie (hochwirksames schallabsorbierendes Material): Der Geräuschpegel im Umfeld der Leuchte wird spürbar gesenkt (Planungsparameter stehen zur Verfügung)

PROFESSIONAL LIGHTING SYSTEM WITH EXTREMELY LARGE SOUND-ABSORBING MASS

By utilizing “Stress Reversing” technology, we significantly reduce noise levels in the vicinity of the acoustic luminaire (planning parameters are available)

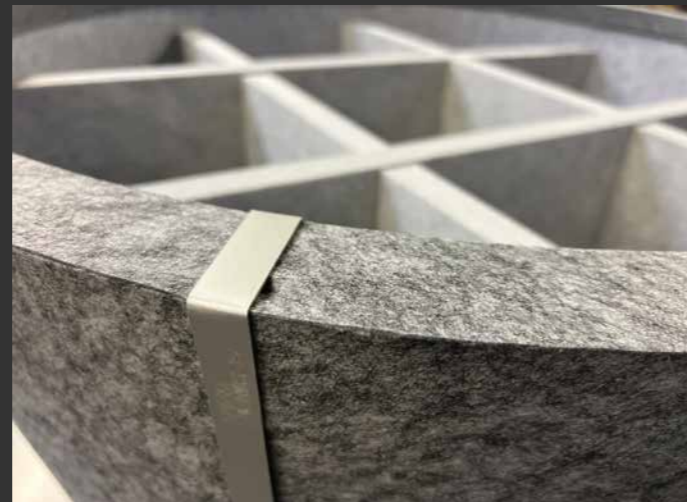

STRONG 16

MINIATURISIERUNG PERFEKTIONIERT | MINIATURISATION PERFECTED

Vielfältiges DALI-Stromschienensystem in 16 mm Breite - sehr schlankes Design
Umfangreiche Auswahl an Strahlern und Pendelleuchten von ca. 300 lm bis zu 3.000 lm

Versatile DALI track system, only 16 mm in width
Very sleek design
Extensive selection of spotlights and pendant lights ranging from approximately 300 lm to 3,000 lm



GLOSSAR | GLOSSARY

Wir verbessern kontinuierlich unsere Produkte in Bezug auf Leistung, Material und Qualität. Die aktuellen und garantierelevanten Produktinformationen und Preise können daher von den hier dargestellten Aussagen abweichen. Bei Maßangaben handelt es sich um ca. - Abmessungen. UVP: Listenpreise ohne gesetzliche Mehrwertsteuer in EURO. Es gelten unsere Verkaufs- und Lieferbedingungen. Die aktuellen Daten finden Sie auf unserer Homepage schmitz-wila.com.

Sonderanfertigungen nach Maß
Maßgeschneiderte Lösungen für individuelle Planungsaufgaben:
Auf Anfrage fertigen wir Leuchten in Sondergrößen nach Maß.

Oberflächen in RAL-Farben
Auf Wunsch lackieren wir die Gehäuseoberflächen unserer Leuchten in nahezu jeder RAL-Farbe. Dies ermöglicht eine perfekte Anpassung der Leuchten an innenarchitektonische Farbkonzepte

Leuchtschirme in Sonderfarben
Wir bieten unsere Leuchtschirme in 30 Standardfarben an. Weitere Farben und Materialqualitäten können projektbezogen umgesetzt werden.

Angaben und Toleranzbereich
Für viele Leuchten besteht ein umfangreicher Geschmacks-, Gebrauchsmuster-, Patent- und Markenschutz. Werkstoff-, Konstruktions- und Programmänderungen bleiben uns vorbehalten. Aussagen sind keine Eigenschaftszusicherungen. Der Toleranzbereich der lichttechnischen Daten liegt bei ca. +/- 10%. Lichtoptiken beeinflussen die angegebenen Werte zusätzlich. Abbildungen und Zeichnungen sind unverbindlich. Es gelten unsere Verkaufs- und Lieferbedingungen.

Planungsdaten
Dieses Printmedium gibt Ihnen einen kompakten Überblick über das aktuelle SCHMITZ-WILA Produktprogramm. Alle zur Planung und Bestellung erforderlichen technischen Produktdaten finden Sie tagesaktuell im Internet auf unserer Homepage www.schmitz-wila.com.

Die Komponentenfertigung und Leuchtenendmontage erfolgt auf höchstem Niveau, basierend auf internationalen Normen und Anforderungen. Auch am Ende des Produktzyklus stehen wir in der Verantwortung.
RoHS - Unsere Produkte entsprechen der RoHS-Richtlinie (Restriction of the use of certain hazardous substances) zur Beschränkung der Verwendung bestimmter gefährlicher Stoffe in Elektronikgeräten.
WEEE - Unsere Produkte entsprechen der WEEE-Richtlinie (Waste Electrical and Electronic Equipment) zur Elektronikschrottverordnung.
Interseroh - Rücknahme, Verwertung und Entsorgung von Elektro- und Elektronikaltgeräten sowie deren Umverpackung erfolgt über Interseroh innerhalb Deutschlands.

Garantierte Qualität
SCHMITZ-WILA garantiert für 5 Jahre, dass die Produkte der Marke SCHMITZ-WILA bei bestimmungsmäßigem Gebrauch frei von Herstellungs- und/oder Materialmängeln sind. Diese Herstellergarantie gilt für alle hier aufgeführten Standardprodukte und deren Varianten. Weitere Details zur Garantie und zur erforderlichen Registrierung finden Sie auf unserer Homepage schmitz-wila.com.

SYMBOLE | ICONS

- 3000 K Farbtemperatur warmweiß | Colour temperature warm white
- 4000 K Farbtemperatur neutralweiß | Colour temperature neutral white
- CCT-Switch Farbtemperatur einstellbar | Colour temperature adjustable
- 2700 - 6500 K TunableWhite
- Präsenzmelder & Tageslichtsensor | Presence detector & daylight sensor
- Steuerung DALI
- Steuerung ON/OFF
- Farbwiedergabeindex | Colour Rendering Index
- Blendungsbewertung | UGR Unified Glare Rating
- IP Schutzklasse | Protection class
- IK Schlagfestigkeit | Impact resistance
- Bildschirmarbeitsplatztauglich | Suitable for VDU workstations
- Insektendicht | Insect proof
- Werkzeuglose Montage | Installation without tools

We continuously improve our products in terms of performance, material and quality. The current and warranty-relevant product information and prices can therefore deviate from the statements shown here. All dimensions are approximate. RRP: List price without VAT in EURO. Our terms and conditions of sale and delivery apply. You can find the current data on our homepage schmitz-wila.com.

Customised designs made to measure
Tailored solutions for individual planning tasks:
Upon request we will produce luminaires in special sizes to your specifications.

Surface finish in RAL colours
Upon request, we can coat the housing surfaces of our lights in virtually any RAL colour. This enables a perfect match of luminaires with the overall colour schemes of interior design.

Lampshades in special colours
Our shades are offered in 30 standard colours.
Additional colours and materials can be realized for special projects.

Information and Tolerance
Many luminaires are protected by comprehensive design registrations, patents and trademark protections. We reserve the right to change material, design and programme without notice. Statements are not a guarantee of characteristics. Photometric data is subject to a tolerance of +/- 10%. Optical attachments also impact IP values. Pictures and drawings are for illustrative purposes only. Our terms and conditions of sale and delivery apply.

Planning Data
This print media gives a concise overview of the current SCHMITZ-WILA product ranges. All necessary data and specifications for planning and product ordering can be found on our homepage on a daily business www.schmitz-wila.com.

Component manufacturing and luminaire final assembly are at the highest level, based on international standards and requirements. We are also responsible in the end of the product cycle.
RoHS - Our products comply with the RoHS Directive (Restriction of Hazardous Substances) restricting the use of certain hazardous substances in electronic devices.
WEEE - Our products comply with the WEEE Directive (Waste Electrical and Electronic Equipment) on the management of electronic waste.
Interseroh - The return/acceptance, recycling and disposal of electrical and electronic devices and their packaging in Germany is managed through Interseroh.

Guaranteed Quality
SCHMITZ-WILA guarantees that the products of the SCHMITZ-WILA brand will be free of manufacturing and/or material defects with correct usage for 5 years. This guarantee applies for all standard products listed in this brochure and their variants. You can find further details about the guarantee and the required registration on our homepage schmitz-wila.com.

- Ballwurfsicher geprüft | Ball-proof tested
- Leuchte mit Notlichtbatterie | Luminaire with emergency battery (3 h)
weitere Notlichtvarianten auf Anfrage | Emergency variants available on request
- Online-Konfigurator | Online configurator
- Leuchte rund | Luminaire round
- Leuchte quadratisch | Luminaire square

MAßE | DIMENSIONS

- B|W Breite | Width
- D Durchmesser | Diameter
- DA|CO Deckenausschnitt | Ceiling cut-out
- ET|RD Erforderliche Montagetiefe für Einbauleuchten (F-Bedingungen)
Required installation depth for recessed luminaires (F conditions)
- H Höhe | Height
- L Länge | Length
- Q Reflektorgröße quadratisch | Reflector size square
- R Reflektorgröße rund | Reflector size round

SCHMITZ-WILA GmbH
Niedereimerfeld 29
D 59823 Arnsberg

T +49 2932 96770
F +49 2932 967775
info@schmitz-wila.com

NOTES

A series of horizontal dotted lines for writing notes, spanning the left side of the page.

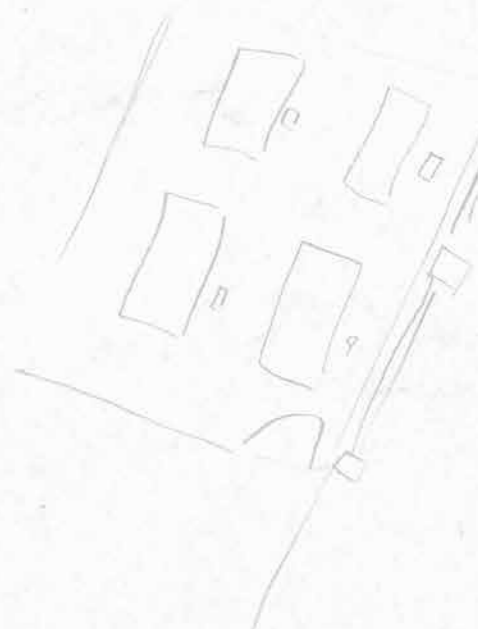
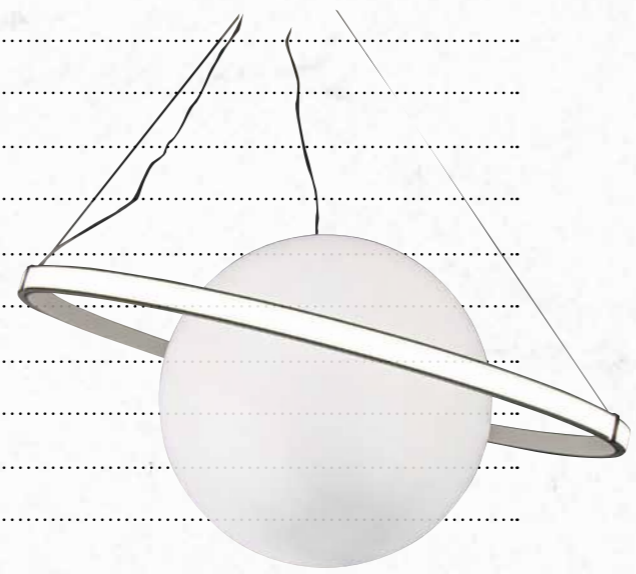

SCHWIMM
W